

a perfect fit™

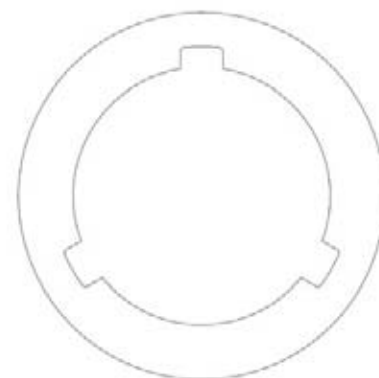

SURGICAL PROCEDURE WITH THE CAMLOG® SCREW-LINE IMPLANT



Options for use
Optional platform switching
Instruments
Surgical procedure
Healing options

camlog



TABLE OF CONTENTS

GENERAL SYSTEM INFORMATION ABOUT THE CAMLOG® IMPLANT SYSTEM	4
CAMLOG® SCREW-LINE IMPLANTS	5
OPTIONAL PLATFORM SWITCHING	7
SURGERY SET CAMLOG®/CONELOG® SCREW-LINE	9
OVERVIEW OF DRILLING SEQUENCES	12
SURGICAL PROCEDURES	14
INCISION LINE	14
IMPLANT BED PREPARATION	15
IMPLANT PACKAGING	24
IMPLANTATION	26
CAMLOG® HEALING CAPS	34
HEALING OPTIONS	35
MATERIALS	38

GENERAL SYSTEM INFORMATION

ABOUT THE CAMLOG® IMPLANT SYSTEM

THE CAMLOG® IMPLANT SYSTEM

The CAMLOG® Implant System is based on many years of clinical and laboratory experience and is a user-friendly, consistently prosthesis-oriented implant system.

All CAMLOG® products are continually updated to the latest technological standards. The CAMLOG® Implant System is being continuously developed and adapted by the CAMLOG research and development team in collaboration with clinics, universities and dental technicians and therefore stays abreast of the latest developments in technology.

The CAMLOG® Implant System is very well documented scientifically. Numerous studies addressing a number of parameters, e.g., implant surface, time of implantation and/or implant loading, primary stability, connection design or type of suprastructure, support this. The long-term results for the CAMLOG® Implant System are convincing.

ATTENTION!

The descriptions that follow are not adequate to permit immediate use of the CAMLOG® Implant System. Instruction by an experienced operator in the management of the CAMLOG® Implant System is strongly recommended. CAMLOG® dental implants and abutments should be used only by dentists, physicians, surgeons and dental technicians trained in the system. Appropriate courses and training sessions are regularly offered by CAMLOG. Methodological errors in treatment can result in loss of the implant and significant loss of peri-implant bone.



CAMLOG® SCREW-LINE IMPLANTS

INTRODUCTION

In their geometry, CAMLOG® SCREW-LINE Implants represent conical screw implants and are available with Promote® plus surface (0.4 mm machined implant neck) and Promote® surface (1.4 mm machined implant neck).

The CAMLOG® SCREW-LINE Implant is suitable for both late implantations but also for immediate/delayed immediate implantations. The selected healing technique can be either submerged or transgingival. The implant is easily inserted because the taper of the implant body (3° – 9° depending on length and diameter) induces self-centering. The self-tapping thread provides a continuous grip on the bone and high primary stability. Compared to the Promote® surfaces, the macrogeometry of the solid screw combined with the Promote® plus surface offers a larger bone contact surface.

INNER IMPLANT CONFIGURATION WITH SQUARE GROOVES (K-SERIES) FOR PLATFORM SWITCHING

The inner implant configuration of the CAMLOG® SCREW-LINE Implants with Promote®- and Promote® plus surfaces is provided with square grooves (K-Series). Only these implants allow the use of the platform switching method.

The CAMLOG® healing caps PS, CAMLOG® impression posts PS (open and closed tray) and CAMLOG® abutments PS must be used only with the CAMLOG® SCREW-LINE implants with the K article numbers (K-Series). The option of platform switching using the CAMLOG® Implant System is possible only with these components!

NOTE

The existing surgical instruments for SCREW-LINE are still useable without restrictions for the CAMLOG® SCREW-LINE Implants of the K-Series.

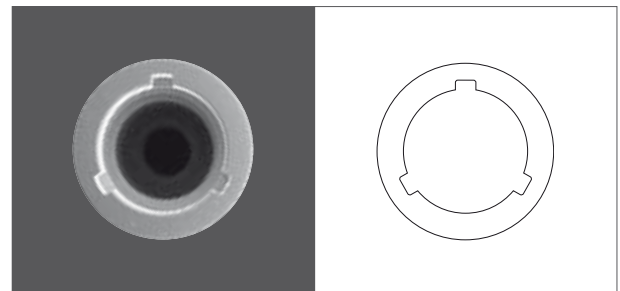
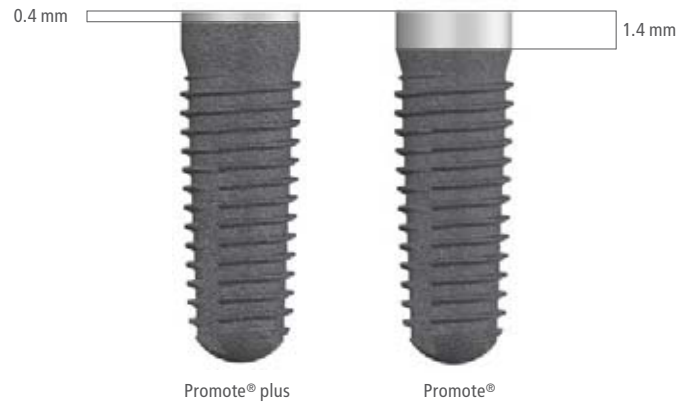

INDICATION RANGE FOR THE PROMOTE® PLUS SURFACE

A deeper coronal implant shoulder is especially beneficial in treating esthetically challenging areas. The machined segment of a CAMLOG® SCREW-LINE Implant with Promote® plus surface measures only 0.4 mm. The implant is inserted into the bone as far as this segment. The following clinical prerequisites should be present:

- Normal to thick biotype
- Gingival height of at least 3.0 mm
- Minimum width of 1.0 mm of the attached gingiva
- Minimum distance of 2.0 mm between the attached gingiva and the mimetic musculature

Apart from these requirements, the range of indications and the implant bed preparation for CAMLOG® SCREW-LINE Implants are identical for both Promote® and Promote® plus surfaces.

IMPLANT DIMENSIONS

CAMLOG® SCREW-LINE IMPLANT WITH PROMOTE® PLUS SURFACE

Implant lengths and diameters

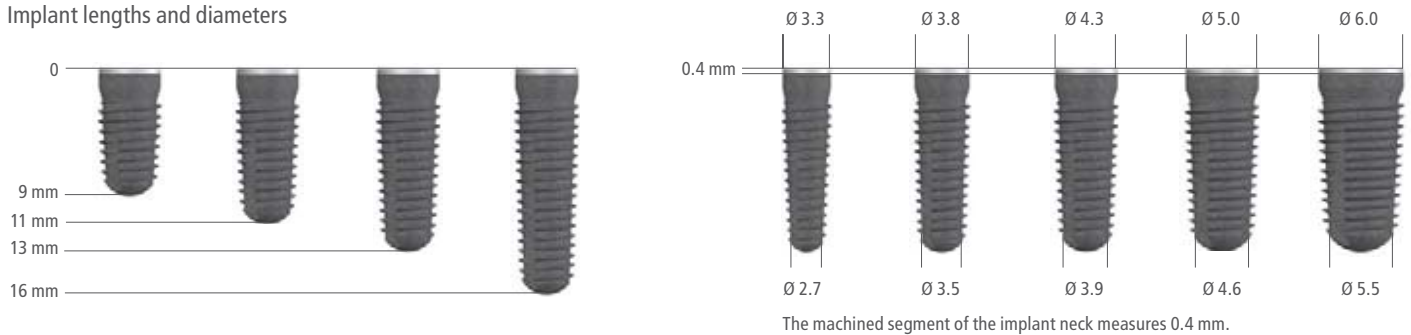

CAMLOG® SCREW-LINE IMPLANT WITH PROMOTE® SURFACE

Implant lengths and diameters

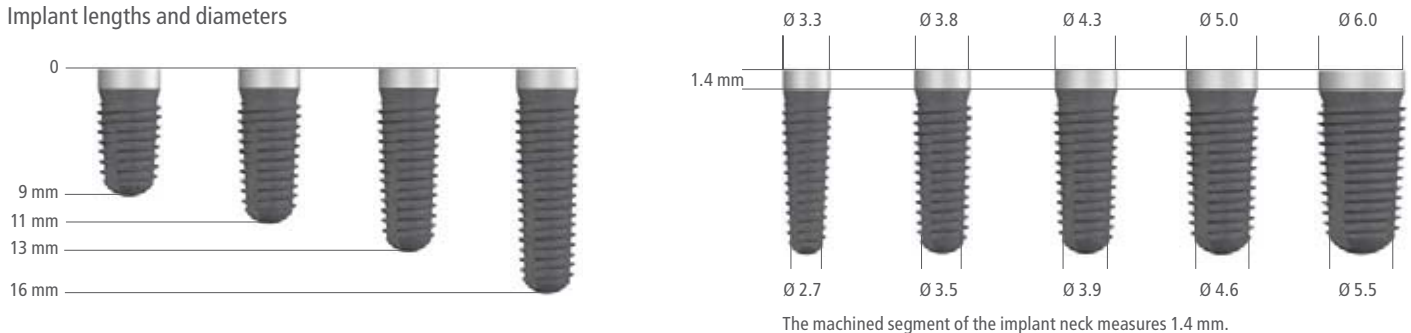

OPTIONAL PLATFORM SWITCHING WITH CAMLOG® SCREW-LINE IMPLANTS

CAMLOG® SCREW-LINE IMPLANT INNER CONFIGURATION FOR PLATFORM SWITCHING

In order to facilitate the platform switching option for CAMLOG users, the grooves in the inner implant configuration of the CAMLOG® SCREW-LINE Implants (Promote® and Promote® plus), unlike the grooves of the CAMLOG® ROOT-LINE Implants, have a shorter, square design. The square grooves design facilitates a restoration using prosthetics components suitable for platform switching, which have a tapered diameter in the apical section and do not completely cover the implant shoulder support. The CAMLOG® healing caps PS, CAMLOG® impression posts PS (open and closed tray) and CAMLOG® abutments PS of the K-Series must be used only with the K-Series CAMLOG® SCREW-LINE implants. CAMLOG® SCREW-LINE implants of the K-Series can only be connected with K-Series CAMLOG® abutments (K article numbers).

CAMLOG® TUBE-IN-TUBE™ IMPLANT-ABUTMENT CONNECTION WITH SQUARE IMPLANT GROOVES AND SQUARE ABUTMENT CAMS

Due to their shortened grooves, CAMLOG® SCREW-LINE Implants with K article numbers cannot be supplied with abutments with J article numbers (long cams).

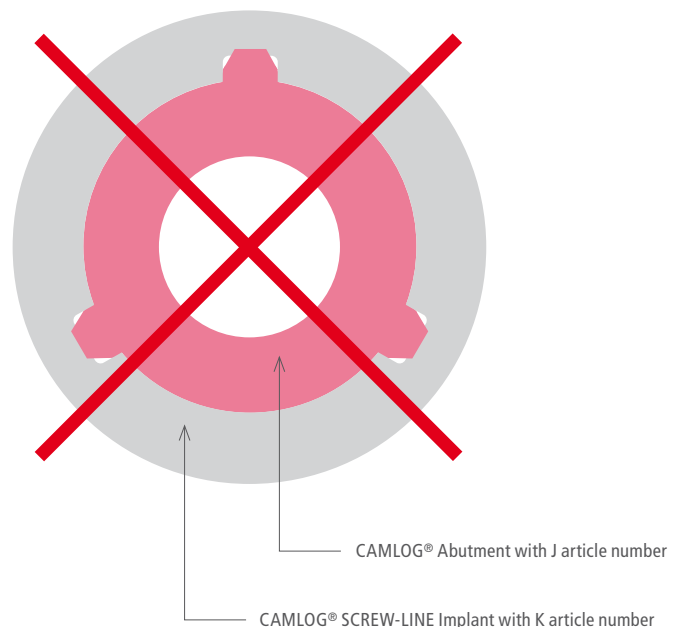
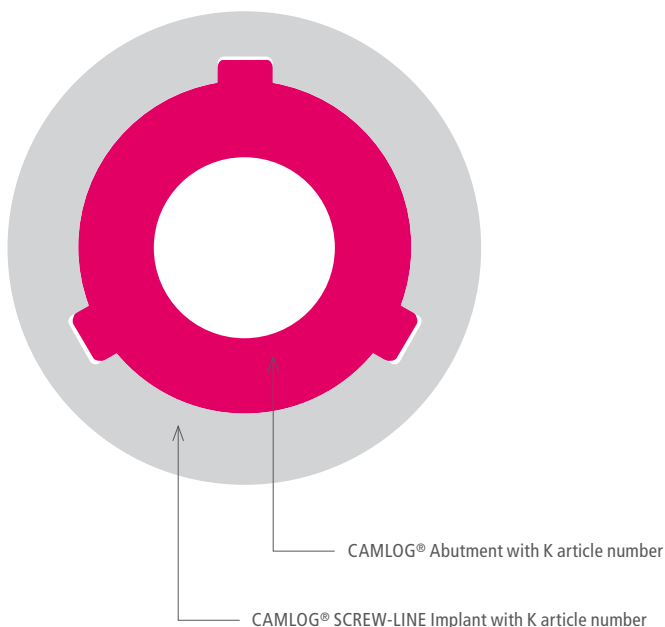

NOTE

The platform switching option must only be used with the CAMLOG® SCREW-LINE implants with K article numbers and prosthetics components PS with K article numbers (K-Series)!

PROSTHETIC COMPONENTS FOR PLATFORM SWITCHING WITH CAMLOG® SCREW-LINE IMPLANTS (K-SERIES)

CAMLOG® HEALING CAPS PS FOR PLATFORM SWITCHING

The CAMLOG® healing caps PS (cylindrical, wide body, bottleneck) are tapered in diameter in the area of the implant shoulder and thus enable the soft tissue to adapt over the implant shoulder.

IMPORTANT NOTE

If CAMLOG® healing caps PS are used for healing, the later prosthetic restoration, incl. the impression, must use CAMLOG® prosthetics components PS for platform switching to prevent tissue injury.



CAMLOG® IMPRESSION POSTS PS, OPEN AND CLOSED TRAY, FOR PLATFORM SWITCHING

Use of the CAMLOG® healing caps PS requires application of the geometrically adapted CAMLOG® impression posts PS for platform switching due to soft tissue adaptation over the implant shoulder.



CAMLOG® TEMPORARY ABUTMENT PS, CAMLOG® ESTHOMIC® ABUTMENT PS, AND CAMLOG® UNIVERSAL ABUTMENT PS FOR PLATFORM SWITCHING

The CAMLOG® abutments PS are also tapered in the area of the shoulder support making it possible to adapt soft tissue over the implant shoulder for the prosthetic restoration.



NOTE

All CAMLOG® prosthetic components for platform switching are marked "PS" and provided with K article numbers (K-Series).

SURGERY SET CAMLOG®/CONELOG® SCREW-LINE

The surgery set CAMLOG®/CONELOG® SCREW-LINE contains the surgical instruments required for implant bed preparation (drills and taps for Ø 6.0 mm are not included):

- Round bur
- Pilot drill
- Pre-drill
- Paralleling pin
- Depth stops
- Form drill with mounted depth stops
- Form drill cortical bone
- Tap
- Screwdriver
- Driver ISO shaft for angle hand piece
- Drivers for implants
- Drill extension
- Adapter ISO shaft for torque wrench
- Tap adapter
- Torque wrench
- Holding key for insertion post

The surgery set is autoclavable with the instruments enclosed.



SURGERY SET CAMLOG®/CONELOG® SCREW-LINE



SYSTEMATIC ORGANIZATION OF THE SET

The drills are arranged in the set according to treatment sequence and are color-coded or sorted by implant diameter. Color lines mark the exact sequence of drill use. Form drills are provided with depth stops. Form drills cortical bone and taps with hexagon are available for optional use with bone qualities 1 or 2 (Lekholm & Zarb, 1985).



There is a separate layout for depth stops for pilot drills and pre-drills and for paralleling pins. The holding key for insertion post is located in the storage compartment with cover.



The torque wrench, tap adapter, drivers (short / long) for screw implants, driver for screw implants ISO shaft for angled handpiece, adapter ISO shaft for angled handpiece/ torque wrench, drill extension ISO shaft, and the screwdrivers (short/ long, manual/ torque and long ISO shaft) are arranged in the surgical/prosthetic instruments area.

COLOR CODING OF CAMLOG®/CONELOG® SURGICAL AND PROSTHETIC PRODUCTS

	Color	Diameter
●	gray	3.3 mm
●	yellow	3.8 mm
●	red	4.3 mm
●	blue	5.0 mm
●	green	6.0 mm

ORGANIZATION OF THE SURGICAL AND PROSTHETIC INSTRUMENTS

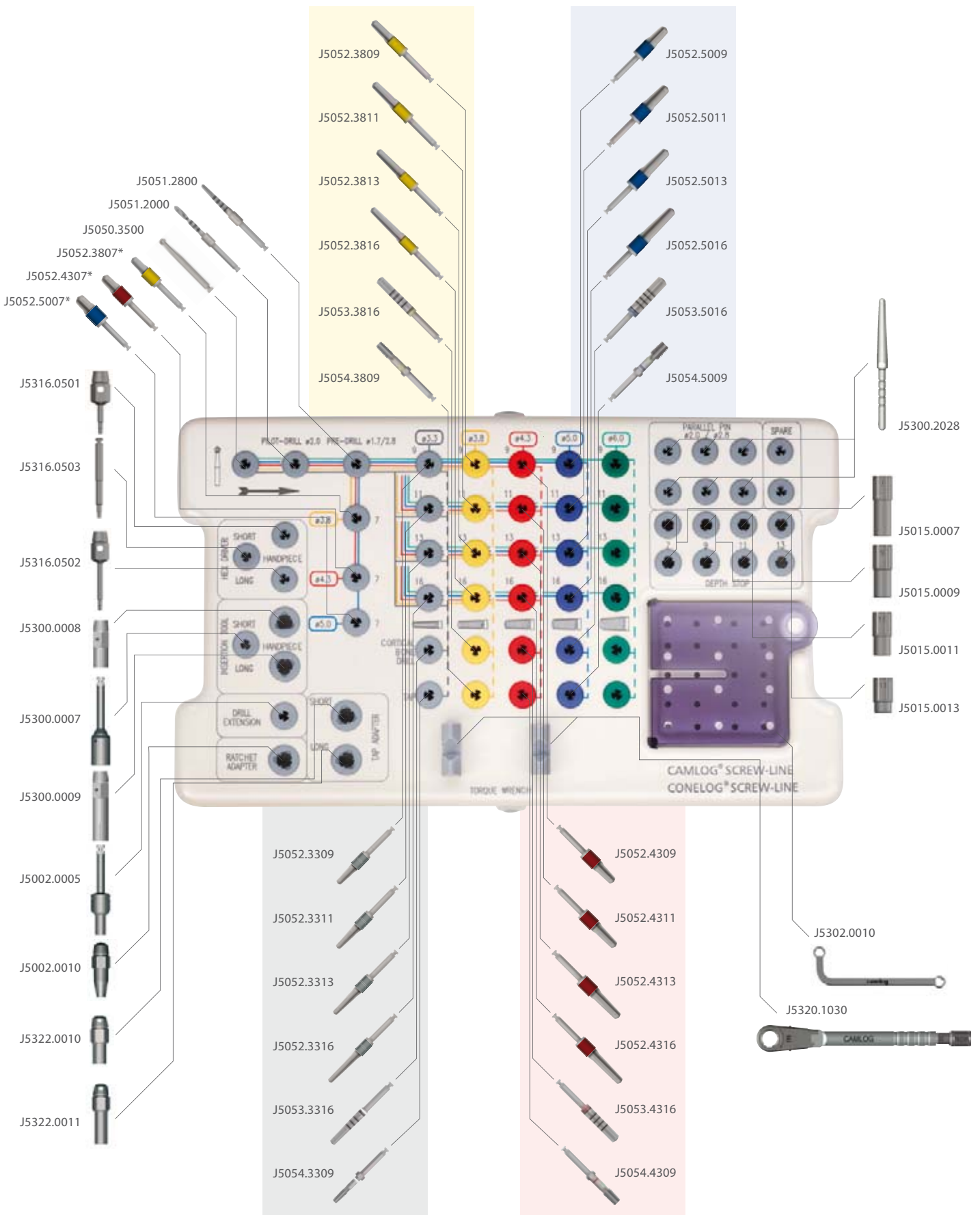

*Form drills for CONELOG® SCREW-LINE implants, length 7 mm

OVERVIEW OF DRILLING SEQUENCES

IMPLANT BED PREPARATION

Overview of the implant bed preparation.

- Punch mark the desired implant position with the Ø 2.3 mm round bur
- Deep drill along the implant axial line with the Ø 2.0 mm pilot drill
- Check with the Ø 1.7–2.8/2.0 mm paralleling pin with depth marks
- Pre-drill with the Ø 1.7–2.8 mm pre-drill
- Check with the Ø 1.7–2.8/2.0 mm paralleling pin
- Shape with the form drill
- Probe the implant bed hole for its bony end
- Cortical bone drilling (for bone quality 1)
- Tap SCREW-LINE (for bone quality 1 and 2).

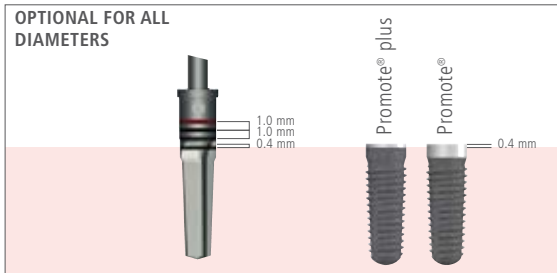

NOTE

The range of indications and the implant bed preparation for the CAMLOG® SCREW-LINE implant with Promote® plus and Promote® surfaces are identical.

Where bone quality is 1* or 2*, we recommend using the tap. Form drills cortical bone enable reduced-torque implantation in the cortical bone for bone quality 1*.

CB: Cortical Bone

*bone quality according to Lekholm & Zarb, 1985

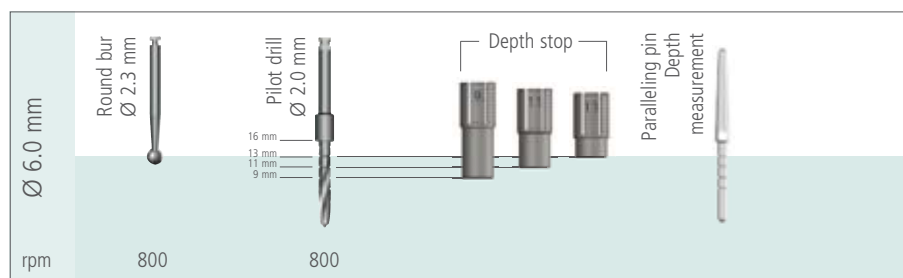
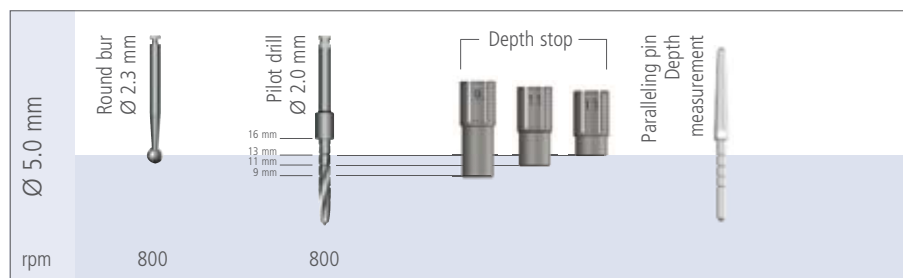
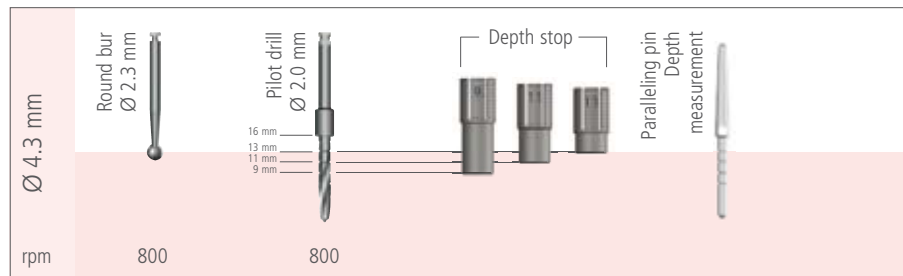
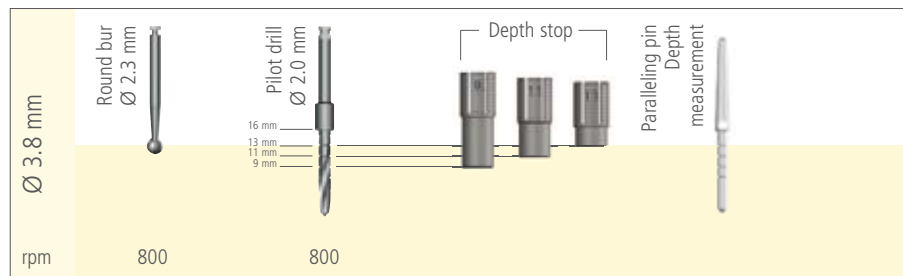
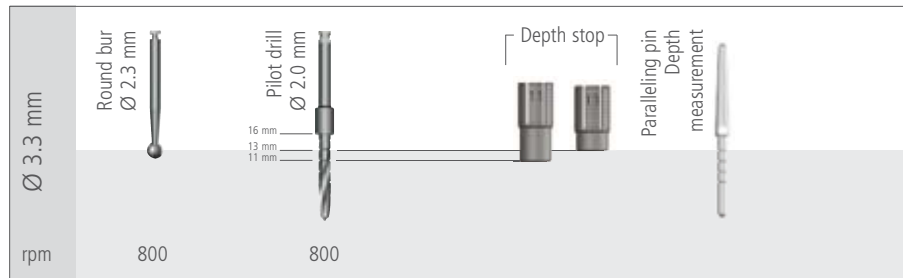

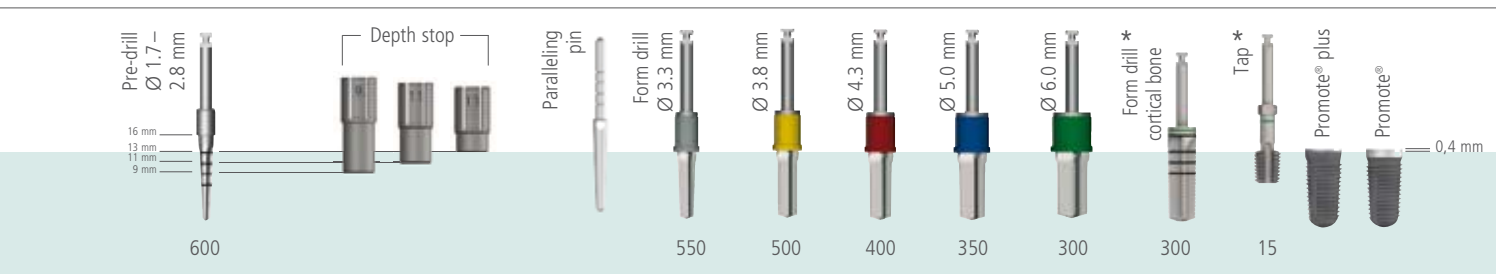
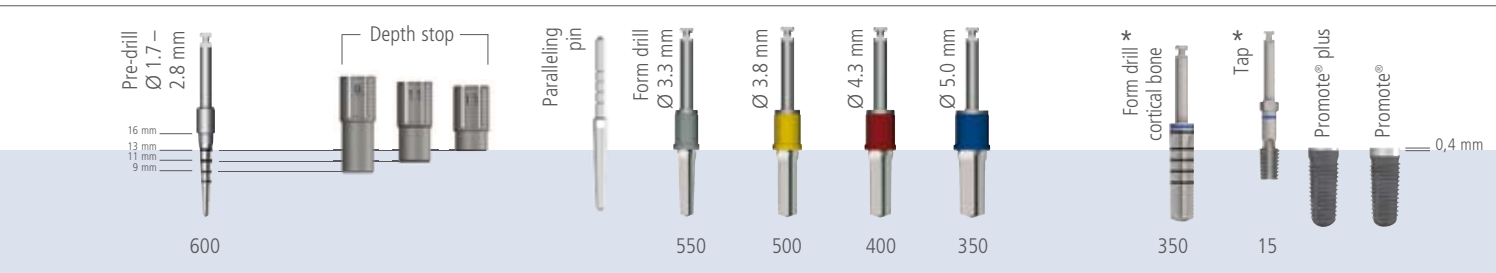
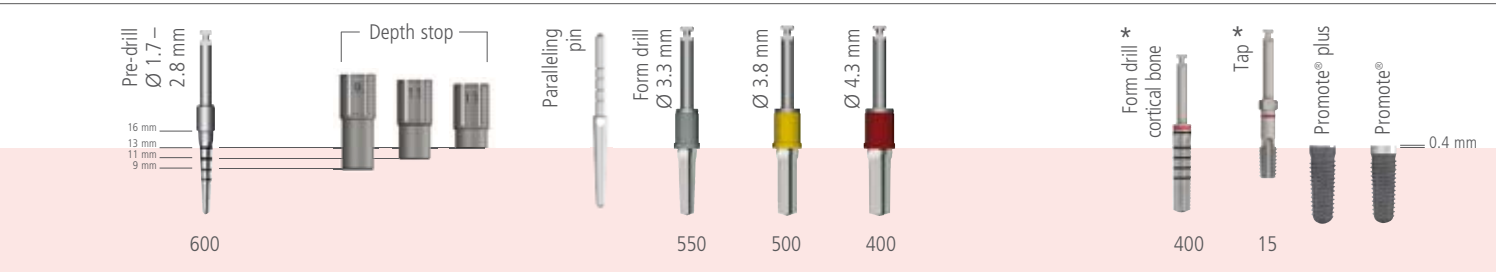
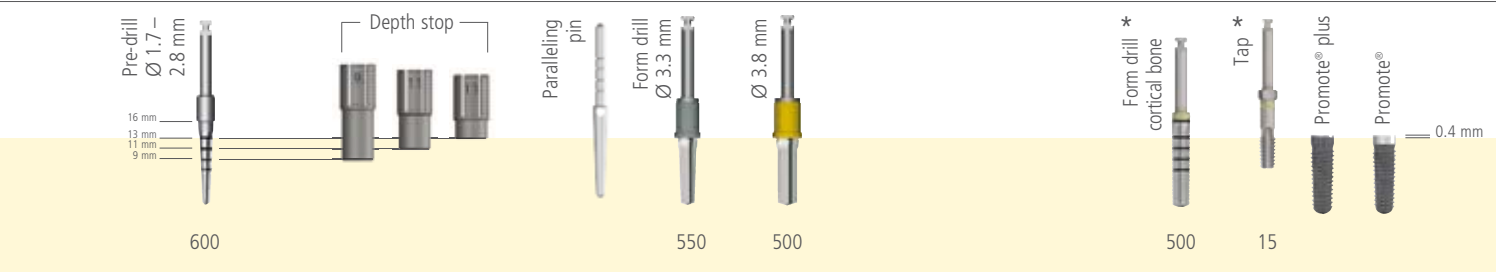
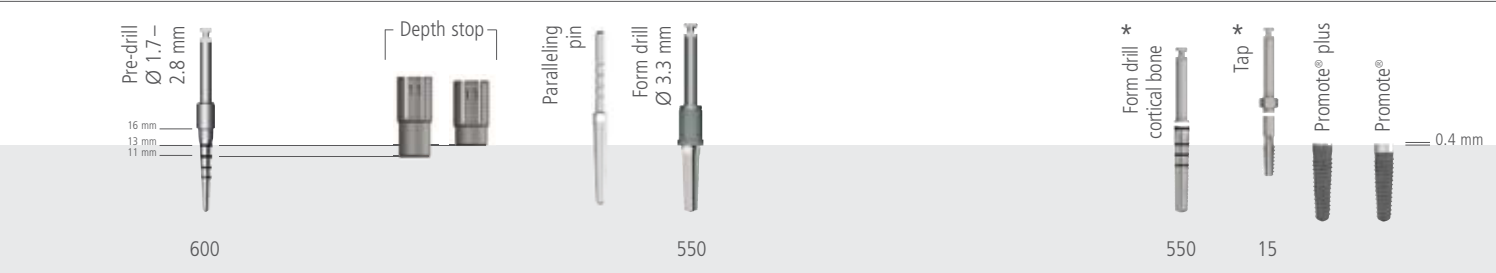

SURGICAL PROCEDURE

INCISION LINE

The indication used as an example shows the insertion of a Ø 4.3mm/length 13 mm CAMLOG® SCREW-LINE Implant in the posterior mandible. The implantation technique is one-step transperiosteal. A split flap preparation is selected for the incision line. We recommend this procedure in cases where there is adequate bone-width and a bone augmentation is not necessary. We recommend a split flap preparation only where the mucosal thickness is adequate. Otherwise, a full mucoperiosteal flap preparation should be made.

Following a somewhat lingual, paracrestal mucosal incision, a predominantly epiperiosteal flap is created on the vestibular aspect. The muscle is divided and the preparation is continued for approximately another 5 mm. The mucosa is separated 2–3 mm lingually to facilitate later suturing.

Following marking of the desired implant position (if necessary, with the aid of a drilling template) the periosteum is removed circularly in the area of this site alone (with a gingival punch or scalpel). This is followed by shaping of the implant bed to match the selected implant diameter and length, using the instruments provided for the CAMLOG® SCREW-LINE Implants.

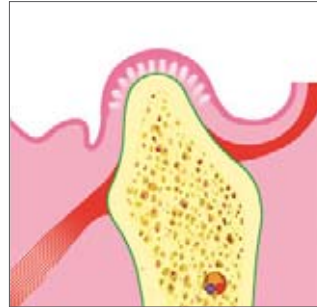

Initial situation



Mucosal incision



Epiperiosteal split-flap preparation



Removal of the periosteum at the implantation site

IMPLANT BED PREPARATION

Shaping the implant bed includes cortical bone marking, pilot drilling, pre-drilling, and form drilling.

The pilot drill hole and pre-drill hole define the depth and axis of the implant bed and ensure conservative bone preparation by enlarging the diameter in small gradations.

DRILL EXTENSION

A drill extension is available to prevent resting of the angled handpiece on the remaining dentition during preparation of the implant bed adjacent to elongated teeth.

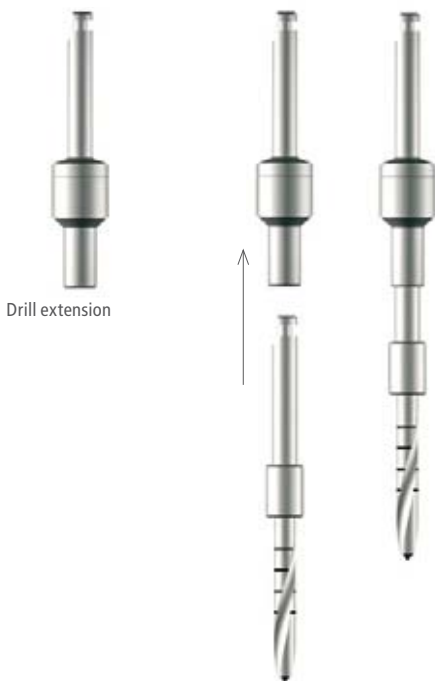

DEPTH STOP SCREW-LINE

The pilot drill SCREW-LINE, reduced coil, and pre-drill have a maximum working length of 16 mm. The drilling depths of 7*, 9, 11, and 13 mm are lasermarked. Insertable depth stops limit the drilling depths to the selected depths of 9, 11, or 13 mm.



*drilling depth for 7 mm CONELOG® SCREW-LINE Implant

CAUTION!

The pilot drills SCREW-LINE and pre-drills have a reduced diameter at the drill coil. The depth stops SCREW-LINE are compatible only with these drills.

SURGICAL PROCEDURE

PARALLELING PIN SCREW-LINE WITH DEPTH MARKS

On completion of pilot drilling and pre-drilling, the depth and axis orientation of the implant bed are checked with the paralleling pin with depth marks.

The diameter combination 1.7–2.8/2.0 mm permits consecutive use while matching the drill diameter.

Short paralleling pins are available as accessories to check the implant/antagonist alignment.

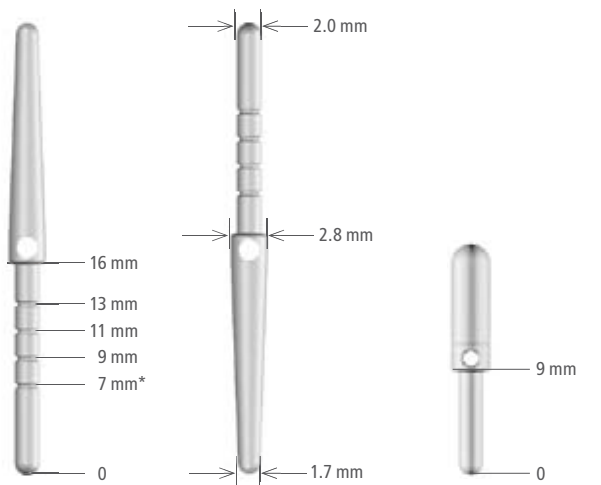

Paralleling pin SCREW-LINE
*drilling depth for 7 mm CONELOG® SCREW-LINE
Implant

Paralleling pin, short

The depth marks and diameter gradations on the paralleling pins allow inspection of the drill depth and drill axis at each stage of pilot drilling and pre-drilling.



PUNCH-MARKING THE CORTICAL BONE

The Ø 2.3 mm round bur is used for punch-marking the cortical bone, which secures the use of the drills to follow. The bur is inserted as far as the bur equator.

Recommended drilling speed: 800 rpm.

PILOT DRILLING

The depth and axis orientation are prepared with the pilot drill with reduced coil. The depth marks on the drill correspond to the implant lengths of 7*/9/11/13 mm. The maximum drilling depth is 16 mm. For safety reasons, a depth stop matching the proposed implant length should be used.

Recommended drilling speed: 800 rpm.

If a drilling template is used, the depth stops may be placed on the pilot drill after the positions have been marked. Once drilling is complete, the depth and axis of the implant bed are checked with the paralleling pin. If several implants are to be placed, a paralleling pin is inserted in the first hole to align the subsequent implant axes.

The pilot drill is aligned parallel to the paralleling pin and visually checked on two planes (sagittal and transversal).

*drilling depth for 7 mm CONELOG® SCREW-LINE Implant



max. 800 rpm

Round bur Ø 2.3 mm



max. 800 rpm

Pilot drill, reduced coil, Ø 2.0 mm

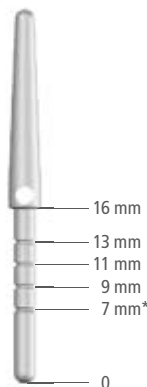

Paralleling pin SCREW-LINE



Punch-marking the cortical bone

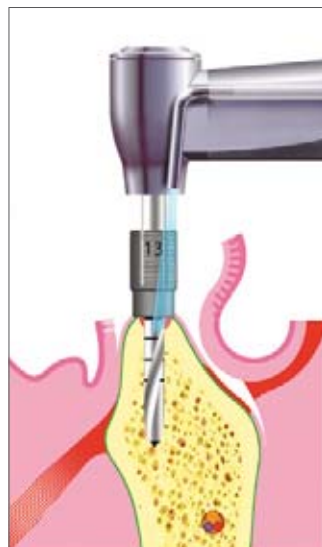

Pilot drilling

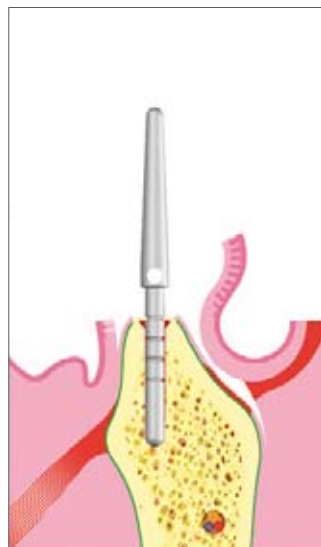

Depth measurement after pilot drilling

SURGICAL PROCEDURE

PRE-DRILLING

A tapered pre-drill SCREW-LINE with the 2.8 mm coronal diameter and 1.7 mm apical diameter is available for the SCREW-LINE configuration. The recommended drilling speed is 600 rpm.

The depth marks on the drill match the implant lengths (7*, 9, 11, and 13 mm). The maximum drilling depth is 16 mm. For safety reasons, a depth stop matching the proposed implant length should be used. Further drilling is performed with the form drills.

*drilling depth for 7 mm CONELOG® SCREW-LINE Implant



Pre-drill SCREW-LINE: Ø 1.7–2.8 mm

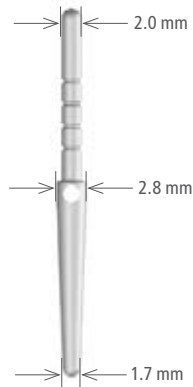

Paralleling pin SCREW-LINE



Pre-drilling

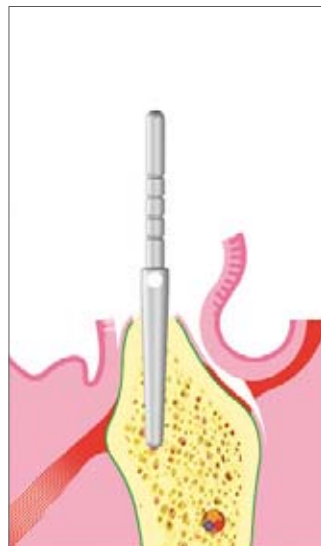

Checking the axial orientation after pre-drilling Ø 1.7–2.8 mm

FORM DRILLING

Diameters and lengths

Diameter- and length-calibrated form drills with reduced drill coil are available for each implant size. The form-drills are color-coded and laser-marked.

The form drills included in the surgery sets are supplied with a color-coded, removable depth stop. This should be used only for the form drill SCREW-LINE. Depending on the specified drilling depth (implant length), the hole diameter is expanded progressively with the series of form drills until the planned implant diameter is reached.

Recommended drilling speeds:

- Ø 3.3 mm 550 rpm
- Ø 3.8 mm 500 rpm
- Ø 4.3 mm 400 rpm
- Ø 5.0 mm 350 rpm
- Ø 6.0 mm 300 rpm



The protocol-specified insertion depth with depth stops in place for SCREW-LINE Implants is the implant length (9/11/13/16 mm) minus 0.4 mm with the circular stop at the bone level, so that the implant shoulder extends 0.4 mm above the ridge.

If a greater insertion depth is desirable (eg, for the platform switching option), the depth stop can be removed and the preparation will then be guided by the depth marks (black). The distances between marks are 1.0 mm. The mark widths are 0.4 mm.

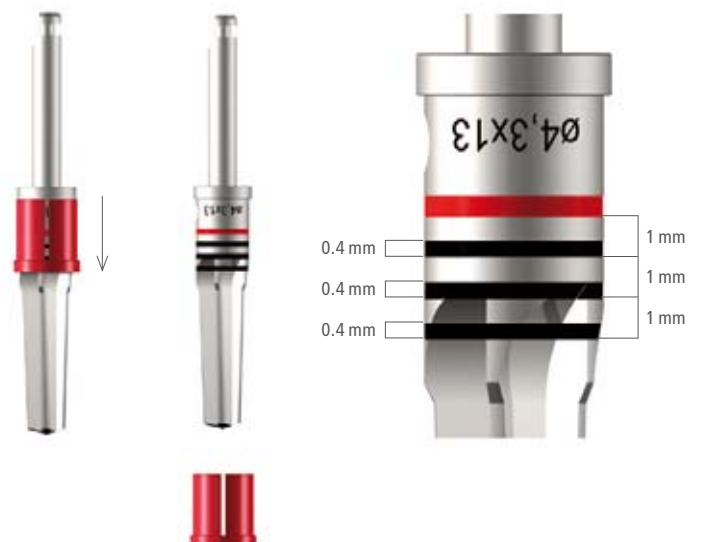

SURGICAL PROCEDURE

DEPTH STOP

During form drilling, the depth stop rests on the highest point of the crest and thereby limits the insertion depth. Since the circular bony ridge may be irregular, the form drills are equipped with a removable depth stop. If a deeper insertion is required for esthetic or functional reasons, the depth stop can be removed and form drilling can be continued for a further 2 mm at most (watch for anatomic structures!). The reusable depth stop can be used on replacement form drills (delivered without depth stops).

The depth stop must be removed before cleaning the drill. The cleaned depth stop must be placed back on the drill before sterilization (see "Preparation Instructions for the CAMLOG®/CONELOG® Implant System", Art. No. J8000.0032). Depth stops may be reordered individually.

CAUTION!

Because of the cutting angle on the drill tip of the form drill, the length exceeds the implant by up to 0.6 mm.

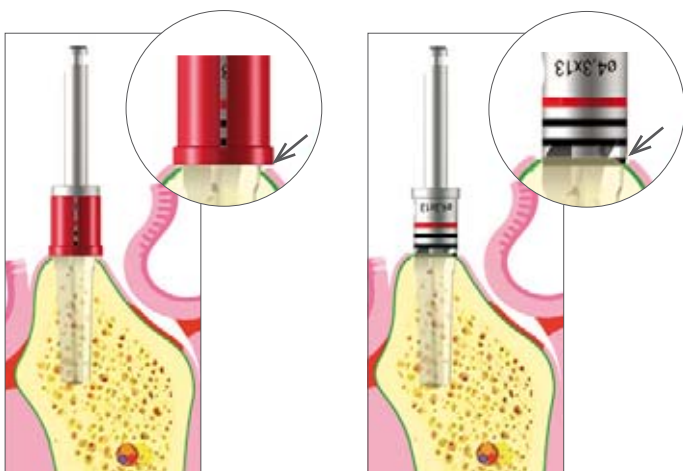

Form drilling with depth stop

Form drilling without depth stop

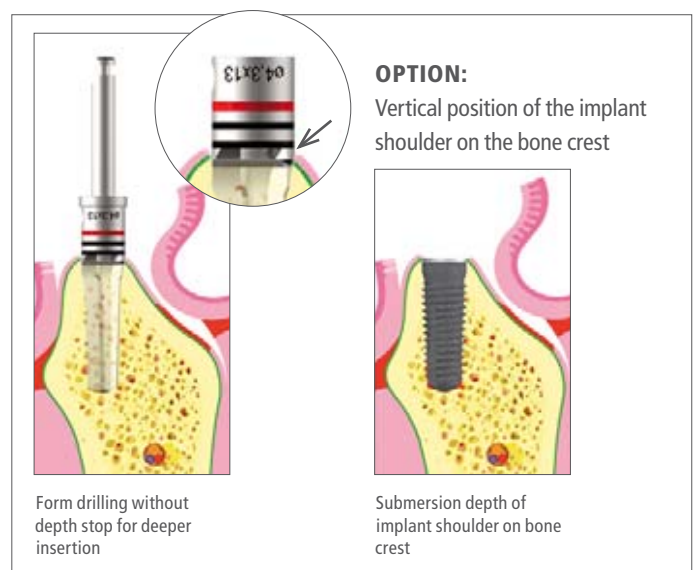

Form drilling without depth stop for deeper insertion

Submersion depth of implant shoulder on bone crest



The bottom edge of the first depth mark corresponds to the implant length with the depth stop in position.

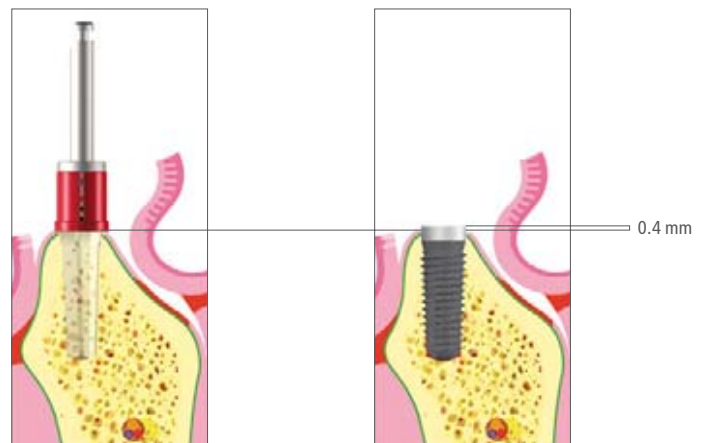

FORM DRILLING

Once pre-drilling is complete, form drills in increasing diameters are used for finishing the final implant bed. Thanks to the close diameter gradation, a gentle preparation of the bone is guaranteed.



Example: Form drilling Ø 4.3 mm

CHECKING THE IMPLANT BED

Results of probing tests for the absence of soft tissue in the implant bed must be filed in the patient chart. If the probe detects soft tissue, this indicates a fenestration into the adjacent tissue by the drill.

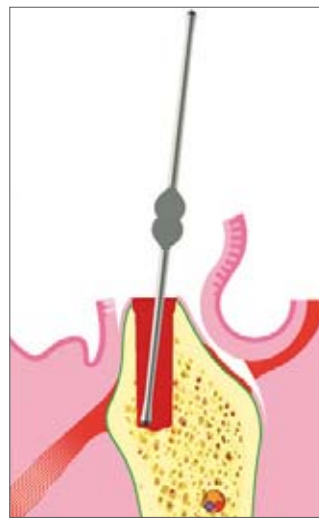

Checking the implant bed

CORTICAL BONE DRILLING

If the bone quality is 1 (Lekholm & Zarb, 1985), the cortical bone drill enables reduced-torque implant insertion through controlled circular expansion of the implant bed in the apical area. The flattened drill tip serves as a depth stop. A color-coded, laser-marked cortical bone drill is available for each implant diameter.

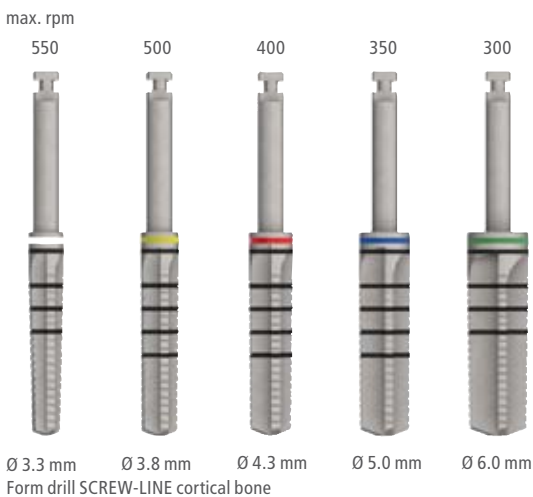

Ø 4.3 mm cortical bone drill for implant length 13 mm

SURGICAL PROCEDURE

IMPLANT TAPPING

All CAMLOG® SCREW-LINE Implants come with a self-tapping thread with a abrasive-blasted, acid-etched surface (Promote®). Use of a tap is recommended for bone qualities 1 and 2 (Lekholm & Zarb, 1985).

The maximum speed should not exceed 15 rpm during power-assisted tapping. We recommend manual tapping.

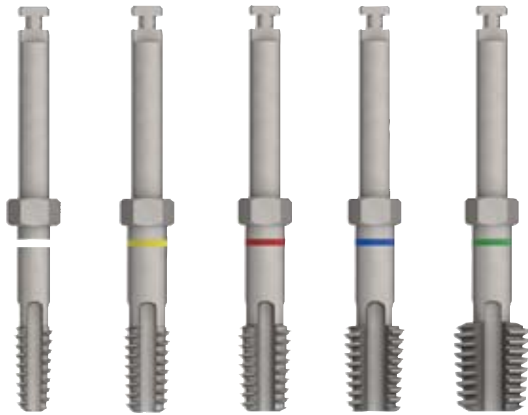

Ø 3.3 mm Ø 3.8 mm Ø 4.3 mm Ø 5.0 mm Ø 6.0 mm

Taps SCREW-LINE with hexagon, max. 15 rpm

Manual tapping is performed with the tap adapters for taps SCREW-LINE and the locked torque wrench. Make sure that the implant bed axis orientation is maintained during insertion and removal of the tap. The limit for insertion of the tap is the upper edge of the cutting blade.



Locked torque wrench



Tap adapters, short / long

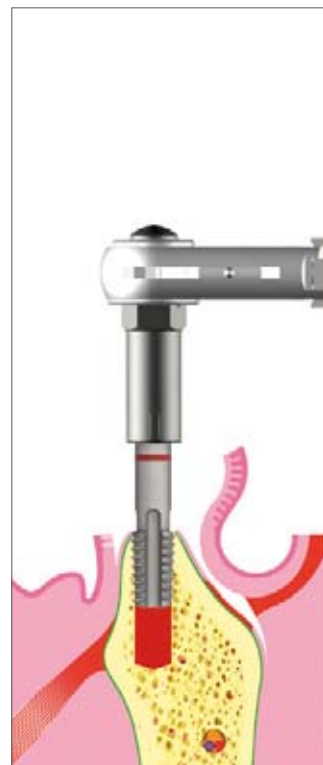
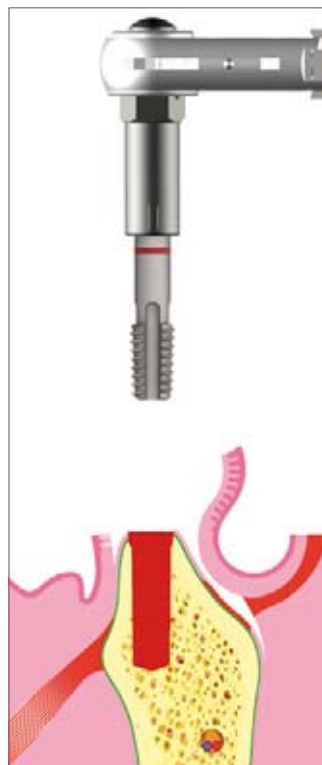

SURGICAL PROCEDURE

IMPLANT PACKAGING

CAMLOG® implants are double-sterile packaged. The primary package (blister) of CAMLOG® SCREW-LINE implants contains the implant with pre-installed insertion post and mounted handle.



Outer package with label (K-Series)



Peel-back pouch



Primary package (sterile) with label (blister pack)



Primary package with visible implant



Opened primary package with implant and mounted handle



CAMLOG® cover screw located in the handle



System information on the label (K-Series)

CAMLOG® SCREW-LINE IMPLANT POSITIONING

Protocol-compliant implant positioning (form drilling with depth stop) is achieved for the CAMLOG® SCREW-LINE implants with attached depth stop when the cylindrical, machined implant shoulder extends 0.4 mm above the crestal bone and one of the 3 groove marks indicates the specified prosthetic position.

If it was decided to set preparation depths for the implants individually by removing the depth stop during form drilling, this should be kept in mind during implant insertion. It is possible to individually position implants with the 1.4 mm implant shoulder and Promote® surface, or the 0.4 mm implant shoulder and Promote® plus surface, vertically to match the drilling depth.

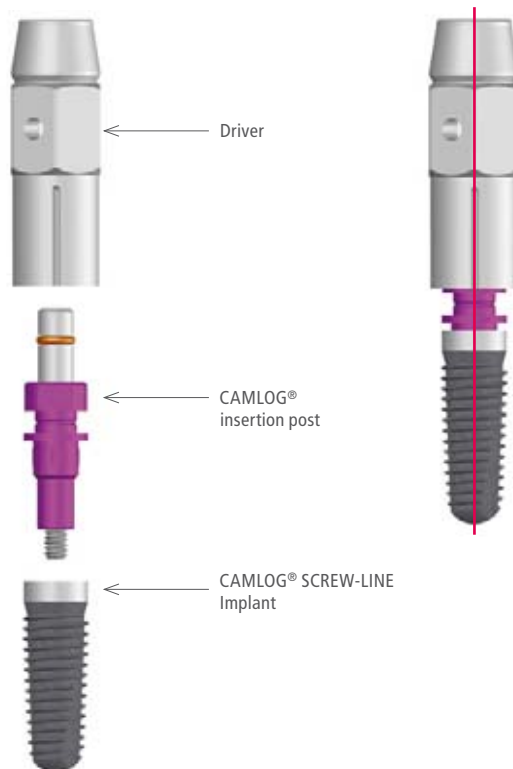

GROOVE POSITIONING

Corresponding to the three grooves of the CAMLOG connection, marks are inscribed on the drivers for the CAMLOG® SCREW-LINE Implants. These permit a check of the groove positions during the insertion and their orientation as required for the prosthesis. If the dental technician has not indicated the groove position, a vestibular orientation is advantageous in most cases since the angle of angulated abutments originates at a groove.

Note: Keep in mind during positioning of the grooves that turning to the next groove position (120°) will cause the screw implant to be inserted about 0.2 mm deeper.

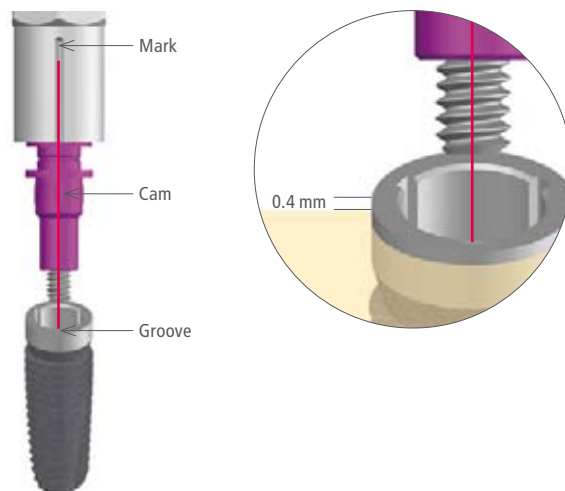

Vestibular orientation of the groove

SURGICAL PROCEDURE

IMPLANTATION

IMPLANT INSERTION

The CAMLOG® SCREW-LINE implant is removed from the primary package (blister) by the sterile handle. Contamination from non-sterile parts must be avoided.

CAUTION!

The silicone plug and CAMLOG® cover screw must be removed from the handle prior to implant insertion.

Taking the implant by the handle, insert it into the implant bed. Make sure to follow the orientation of the implant bed axis. If the hole has been pre-tapped, the position of the thread dog point in the cortical bone must match that on the implant.

TIP: Screw the implant carefully to the left until the thread dog point can be felt. Then, using the handle, screw the implant to the right until it obtains sufficient grip to allow withdrawal of the handle.



Inserting the implant

OPTIONAL ACCESSORIES:

PICKUP INSTRUMENT

If the intraoral space is insufficient to allow insertion of the implant with the handle, the implant can be removed from the handle with the PickUp instrument. Slide the PickUp Instrument between the implant and handle onto the CAMLOG® insertion post and lift off the handle. For the insertion procedure, place the selected driver on the CAMLOG® insertion post. The implant is then inserted into the bone and the PickUp instrument is removed.

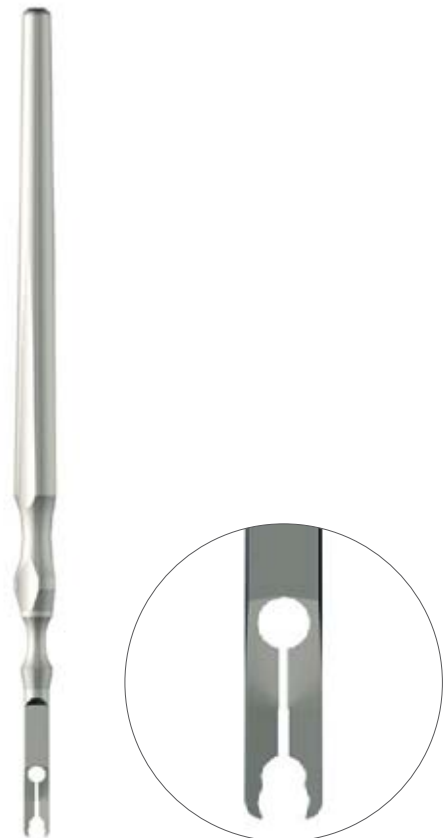

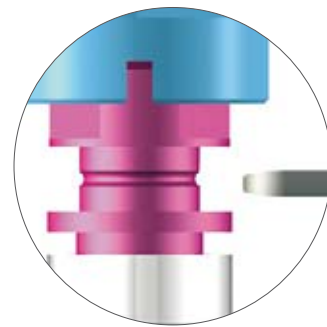

Placing the PickUp on the CAMLOG® insertion post

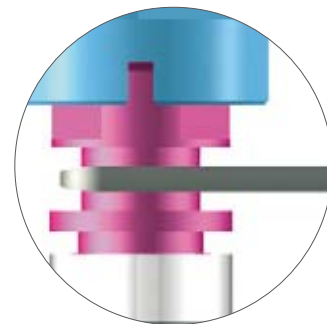

Locked-on PickUp

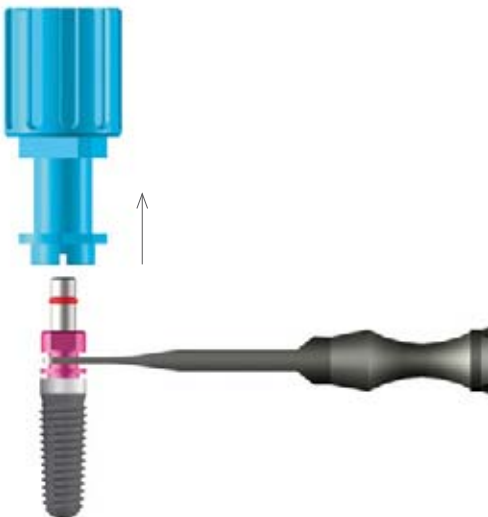

Removing the handle

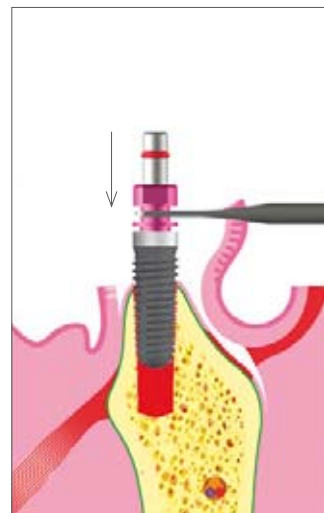

Inserting the implant

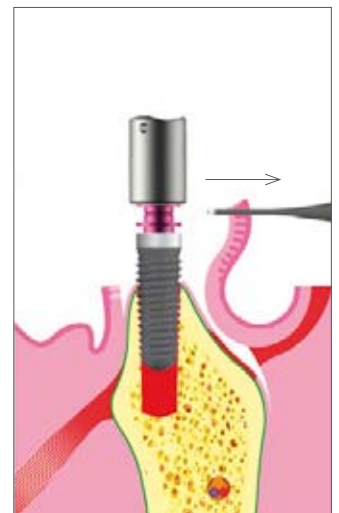

Mounting the driver and removing the PickUp

SURGICAL PROCEDURE

DRIVER

You have three options for the final insertion of the CAMLOG® Implant:

- Power-assisted insertion (A)
- Manual insertion with the torque wrench and driver (B)
- Manual insertion with the cardanic driver (C).

During insertion, make sure to use the mark on the driver for the groove position in the implant (also see page 25, CAMLOG® SCREW-LINE Implant positioning).



Driver for screw implants with ISO shaft



Drivers, short, long



Driver, cardanic



A Power-assisted insertion with the driver for screw implants, ISO shaft (max. 15 rpm).

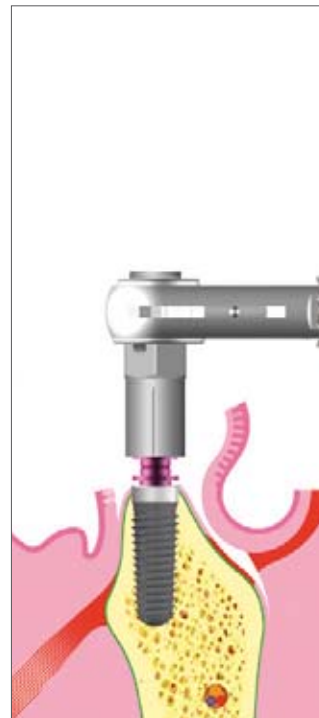

B Manual insertion with the locked torque wrench and driver (short/ long) for screw implants.



C Manual insertion with the cardanic driver.

Next, unscrew the retention screw of the CAMLOG® insertion post with the screwdriver, hex, and remove the insertion post (Caution: Danger of aspiration!). If the implant site has a weak bone structure, a holding key for insertion post is available (as an accessory) to lock the insertion post and prevent implant movement when unscrewing the retention screw.



Screwdrivers, hex, extra short/short/long



Holding key for insertion post



Unscrewing the retention screw



Removing the CAMLOG® insertion post

SURGICAL PROCEDURE

SUBMERGED HEALING

Pick up the CAMLOG® cover screw, previously removed from the handle, with the screwdriver, hex, and insert this manually into the CAMLOG® SCREW-LINE Implant (danger of aspiration!). The cover screw must be tightened by hand only, using the screwdriver, hex.

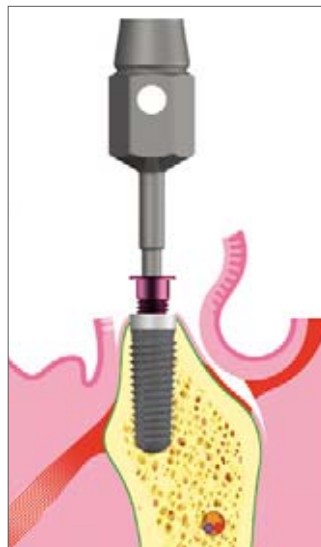

Inserting the CAMLOG® cover screw



CAMLOG® SCREW-LINE Implant with cover screw

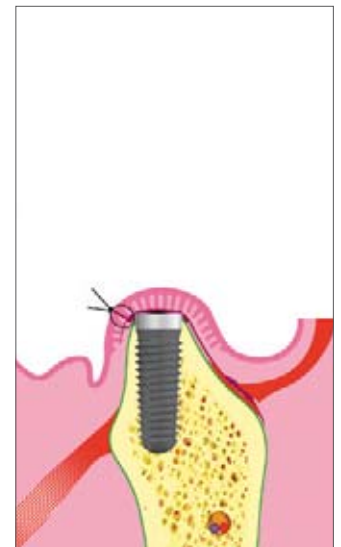

Wound closure

OPEN/TRANSGINGIVAL HEALING

In this example, a CAMLOG® healing cap, cylindrical, is picked up with the screwdriver, hex, and screwed into the CAMLOG® SCREW-LINE Implant (Caution: Danger of aspiration!). The CAMLOG® healing cap should be tightened by hand only, using the screwdriver, hex.



Inserting the CAMLOG® healing cap



CAMLOG® SCREW-LINE Implant with healing cap

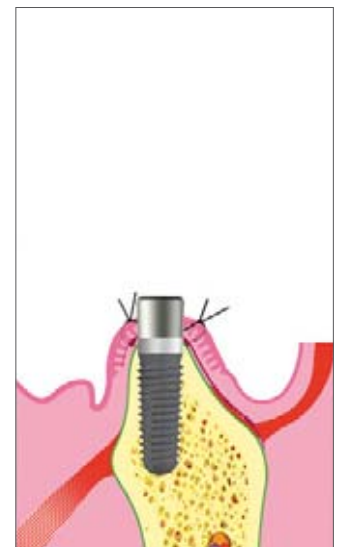

Wound closure

ACCESSORIES

CAMLOG® ADAPTER FOR SCREW IMPLANTS FOR NARROW GAPS AND HOLDING SLEEVE TO GUIDE THE ADAPTER INTO THE IMPLANT

A diameter-reduced CAMLOG® adapter, long, is available for the CAMLOG® SCREW-LINE implant diameters Ø 3.3, 3.8 mm and 4.3 mm for manual insertion into small gaps. Three lateral marks match the cams on the adapter and provide a buccal orientation for one of the CAMLOG® SCREW-LINE Implant grooves. After removal from the primary package (blister) the color-coded holding sleeve with correct diameter is inserted over the endosseous part of the implant to guide the adapter into the implant. The sleeve is squeezed together like a collet at the level of the implant shoulder and the handle is removed.

NOTE

In order to be able to hold the implant tightly and securely in the sleeve, we recommend clamping the sleeve using an artery clip. Then, the handle can be removed, the fixing screw of the insertion post can be unscrewed using a screwdriver, hex, and the insertion post can be removed.

IMPORTANT NOTE

The artery clip, the CAMLOG® adapter and the sleeve must be sterilized prior to use.



CAMLOG® adapter for screw implants, long, Ø 3.3 mm, Ø 3.8 mm and Ø 4.3 mm



Holding sleeve for screw implants to guide the adapter into the screw implant, Ø 3.3 mm, Ø 3.8 mm and Ø 4.3mm



Setting up the sleeve

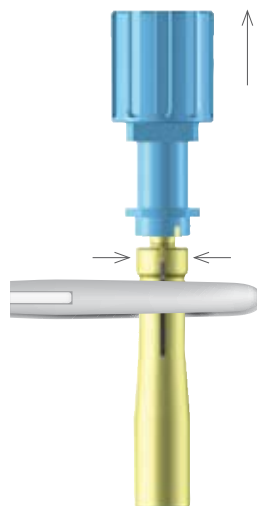

Clamp the sleeve in an artery clip and remove the handle

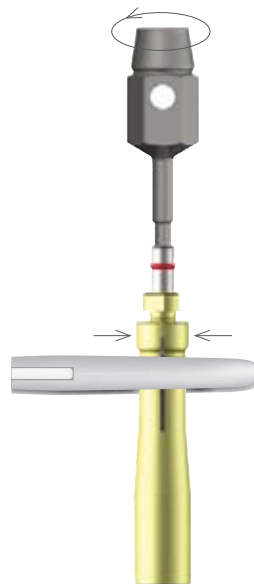

Unscrewing the fixing screw

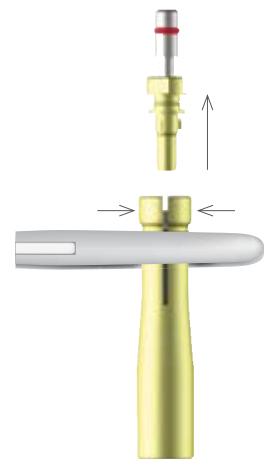

Removing the CAMLOG® insertion post

SURGICAL PROCEDURE

ACCESSORIES

Following unscrewing and removal of the CAMLOG® insertion post, slide the diameter-matching CAMLOG® adapter into the implant until the cams engage the notches. To fasten, manually tighten the retention screw on the adapter. After removal of the sleeve, the CAMLOG® SCREW-LINE Implant can be inserted.

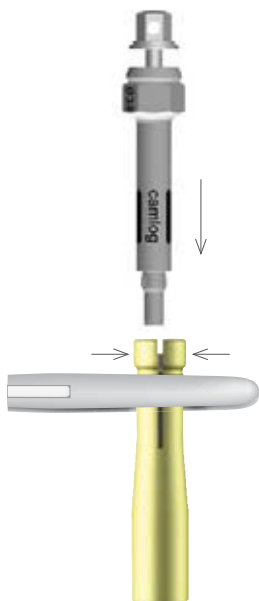

Placing the CAMLOG® adapter

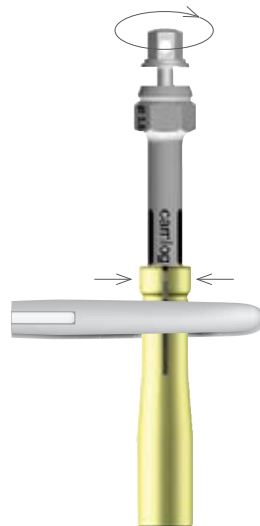

Tightening the fixing screw

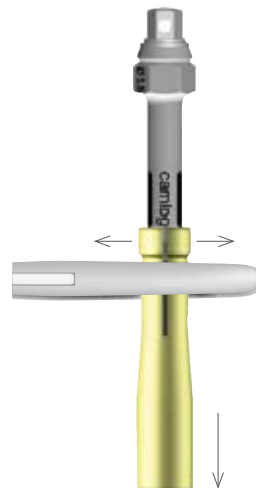

Opening the artery clip and withdrawing the sleeve



CAMLOG® SCREW-LINE implant screw retained with CAMLOG® adapter

For the insertion, place the locked torque wrench over the hexagon of the CAMLOG® adapter and screw the implant to its final position, making sure to line it up with the notched mark.



Inserting the implant



Placing the torque wrench



Tightening the implant in final position

ACCESSORIES

Once the fixing screw is unscrewed, detach the CAMLOG® adapter from the CAMLOG® SCREW-LINE implant. Pick up the CAMLOG® cover screw with the screwdriver, hex, and insert it into the implant manually (danger of aspiration!).

The CAMLOG® cover screw must not be power-tightened. A CAMLOG® healing cap should be used for the transgingival healing method (see pages 34–37).



Unscrewing the fixing screw



Removing the CAMLOG® adapter



Screw retaining the CAMLOG® cover screw



CAMLOG® SCREW LINE implant with CAMLOG® cover screw

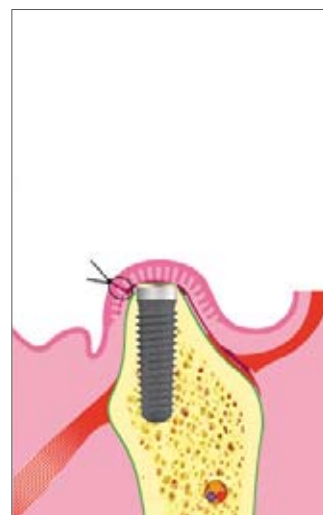

Wound closure



SURGICAL PROCEDURE

CAMLOG® HEALING CAPS

Use of the CAMLOG® healing caps supports the development of the peri-implant soft tissue. CAMLOG® healing caps are available in three different configurations:

- cylindrical
- wide body
- bottleneck

CAMLOG® healing caps are color-coded to match the implant diameter.



CAMLOG® HEALING CAPS	CYLINDRICAL	WIDE BODY	BOTTLENECK
			
DIAMETER	GINGIVAL HEIGHT (GH)	GINGIVAL HEIGHT (GH)	GINGIVAL HEIGHT (GH)
3.3 mm	2.0/4,0 mm	2.0/4.0 mm	4.0 mm
3.8 mm	2.0/4.0/6.0 mm	2.0/4.0/6.0 mm	4.0/6.0 mm
4.3 mm	2.0/4.0/6.0 mm	2.0/4.0/6.0 mm	4.0/6.0 mm
5.0 mm	2.0/4.0/6.0 mm	2.0/4.0/6.0 mm	4.0/6.0 mm
6.0 mm	2.0/4.0/6.0 mm	2.0/4.0/6.0 mm	4.0/6.0 mm

CAMLOG® HEALING CAPS PS FOR PLATFORM SWITCHING

The CAMLOG® healing caps PS (cylindrical, wide body, bottleneck) are tapered in diameter on the apical end and enable the adaptation of soft tissue over the implant shoulder.

IMPORTANT NOTE!

If CAMLOG® healing caps PS are used for healing, the later prosthetic restoration, including the CAMLOG® impression taking, must use CAMLOG® prosthetic components PS for platform switching to prevent tissue injury!

CAMLOG® HEALING CAPS PS	CYLINDRICAL	WIDE BODY	BOTTLENECK
			
DIAMETER	GINGIVAL HEIGHT (GH)	GINGIVAL HEIGHT (GH)	GINGIVAL HEIGHT (GH)
3.8 mm	2.0/4.0/6.0 mm	4.0/6.0 mm	4.0/6.0 mm
4.3 mm	2.0/4.0/6.0 mm	4.0/6.0 mm	4.0/6.0 mm
5.0 mm	2.0/4.0/6.0 mm	4.0/6.0 mm	4.0/6.0 mm
6.0 mm	2.0/4.0/6.0 mm	4.0/6.0 mm	4.0/6.0 mm

PS: Platform Switching

HEALING OPTIONS

HEALING OPTIONS WITH CAMLOG® HEALING CAPS AND CAMLOG® HEALING CAPS PS

CAMLOG® HEALING CAPS, CYLINDRICAL, AND WIDE BODY

The cylindrical and wide body CAMLOG® healing caps are for standard use. After removal of the CAMLOG® cover screw, diameter-matching CAMLOG® healing caps are screwed in manually with a screwdriver, hex. A gingival height ensuring that the healing cap sits 1–1.5 mm supragingivally should be selected. The CAMLOG® impression is taken once the peri-implant soft tissue has been stabilized.



CAMLOG® healing cap, cylindrical



CAMLOG® healing cap, wide body

CAMLOG® HEALING CAPS PS, CYLINDRICAL, AND WIDE BODY

CAMLOG® SCREW-LINE Implants with Promote® plus surface are suitable for the platform switching option. Because the surface is brought further upward, more bone is available close to the implant shoulder. Because the surface is brought further upward, more bone is available in coronal direction. The shift in the horizontal shoulder towards the implant axis at the implant shoulder level ensures more space for soft-tissue management.

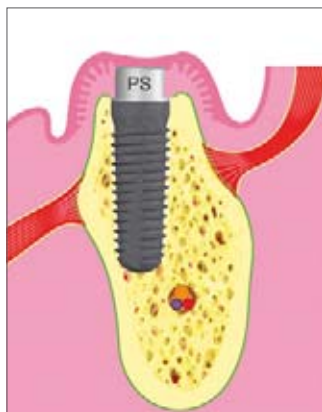

CAMLOG® healing cap PS, cylindrical.
Height 2 mm, for submerged healing

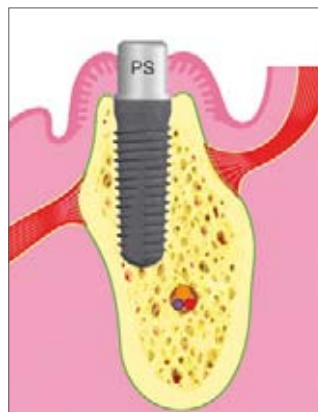

CAMLOG® healing cap PS, cylindrical



CAMLOG® healing cap PS, wide body

SURGICAL PROCEDURE

CAMLOG® HEALING CAPS, BOTTLENECK

In esthetically challenging areas, the treatment outcome can be optimized by using CAMLOG® healing caps, bottleneck. The coronally tapered cross-cut enables soft-tissue generation during healing.

After 3–4 weeks (and before the final organization of the elastic fibers) a CAMLOG® healing cap cylindrical is screwed in. No tissue should be excised. The tissue is coronally suppressed and thereby forms a papilla-like structure. The impression is taken after stabilization of the peri-implant soft tissue.



Healing stage



Soft-tissue generation



Coronal suppression of the soft tissue by substitution with a CAMLOG® healing cap cylindrical

CAMLOG® HEALING CAPS PS, BOTTLENECK

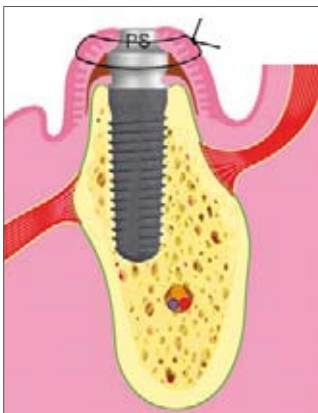

Healing phase with a CAMLOG® healing cap PS bottleneck

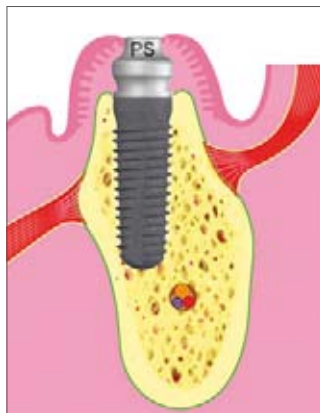

Soft-tissue generation with a CAMLOG® healing cap PS bottleneck



Coronal suppression of the soft tissue by substitution with a CAMLOG® healing cap PS cylindrical

WARNING!

To prevent soft tissue injury, CAMLOG® healing caps PS should only be replaced by CAMLOG® healing caps PS!

TISSUE GENERATION/TISSUE SUPPORT

One-step use
(transgingival)

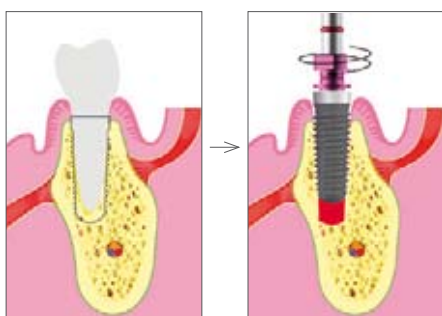

Two-step use
(submerged)

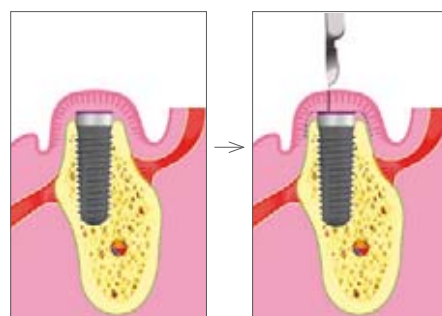

Bottleneck
Tissue generation—step 1

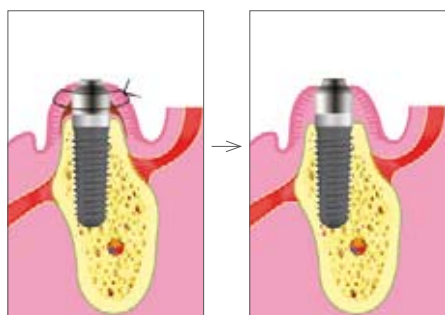

Wide body
Tissue support

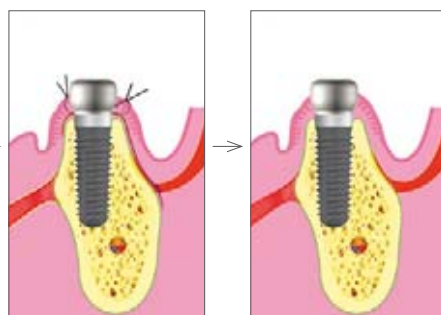

optional

Cylindrical
Tissue generation—step 2

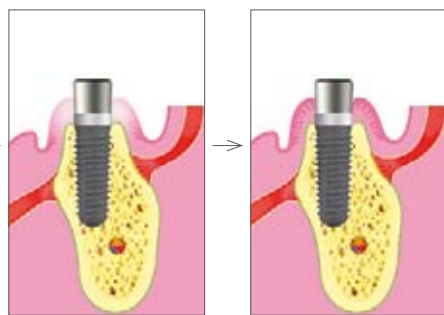

Temporary restoration—CAMLOG®
PEEK Abutment



Final restoration—abutment
with suprastructure



MATERIALS

TITANIUM (GRADE 4)

PROPERTIES

Chemical composition (in %):	O	0.4 max.
	Fe	0.3 max.
	C	0.1 max.
	N	0.05 max.
	H	0.0125 max.
	Ti	> 99.0
Mechanical properties:	Strength	680 MPa min.
	Elongation	10 %

TITANIUM ALLOY (Ti6Al4V ELI)

PROPERTIES

Chemical composition (in %):	Al	5.5–6.75 max.
	V	3.5–4.5 max.
	Fe	0.3 max.
	C	0.08 max.
	N	0.05 max.
	H	0.015 max.
	Ti	~ 90
Mechanical properties:	Strength	860 MPa min.
	Elongation	10 %

PEEK (POLYETHERETHERKETONE)

PROPERTIES

Mechanical properties:	Density	1,38 g/cm ³
	Elongation at tear	>25 %
	Flexural strength	160 MPa
	Melting point	343 °C/649° F

FURTHER DOCUMENTATION

Information on preparation of the surgery sets is available in "Preparation Instructions for the CAMLOG®/CONELOG® Implant System", Art. No. J8000.0032.

Further information about CAMLOG® products is available in the current CAMLOG Product Catalog, in the CAMLOG® Work Instructions and in the CAMLOG® Instruction Manual shipped with CAMLOG® products. See also the website www.camlog.com.

TRADE NAMES AND COPYRIGHT

Protected trade names (trademarks) are not specially indicated. The absence of such notes may not be interpreted to mean that a trade name is unregistered. This document, including all its parts, is protected by copyright. Any use beyond the restricted limits of the copyright law without the agreement of CAMLOG Biotechnologies AG is not permissible and is punishable by law.



+E219J8000063 11



+\$0010028051TT

HEADQUARTERS

CAMLOG Biotechnologies AG | Margarethenstrasse 38 | CH - 4053 Basel | Switzerland
Phone +41 61 565 41 00 | Fax +41 61 565 41 01 | info@camlog.com | www.camlog.com

Manufacturer of CAMLOG®/CONELOG® products: ALTATEC GmbH, Maybachstraße 5, D-71299 Wimsheim, Germany

