

a perfect fit®

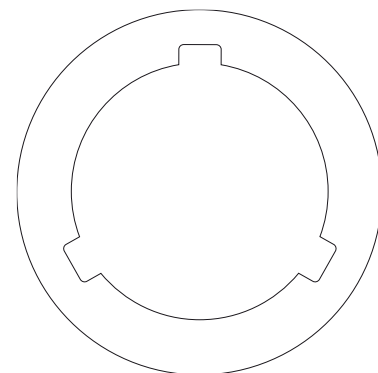

# LOGFIT® PROSTHETIC SYSTEM FOR CEMENTABLE CROWN AND BRIDGE RESTORATIONS



Basic Information  
Impression Taking  
Cast Fabrication  
Prosthetic Restoration  
Insertion

**camlog**



# TABLE OF CONTENTS

<b>GENERAL SYSTEM INFORMATION ON THE CAMLOG® IMPLANT SYSTEM</b>	<b>4</b>
<b>SYSTEM INTRODUCTION</b>	<b>5</b>
GENERAL GUIDELINES FOR THE FABRICATION OF IMPLANT-SUPPORTED PROSTHETICS	5
CAMLOG® TUBE-IN-TUBE™ IMPLANT ABUTMENT CONNECTION	6
NEW CAMLOG® ABUTMENTS WITH K ARTICLE NUMBER (K-SERIES)	7
CAMLOG COLOR-CODING	8
<b>PRODUCT DESCRIPTION</b>	<b>9</b>
INTRODUCTION	9
LOGFIT® ABUTMENTS	10
SYSTEM OVERVIEW	11
<b>APPLICATION</b>	<b>12</b>
SELECTION AND USE OF THE LOGFIT® ABUTMENT	12
LOGFIT® IMPRESSION TAKING	13
LOGFIT® CAST FABRICATION	14
FABRICATION OF THE PROSTHETIC RESTORATION	15
INSERTION AND CEMENTATION OF THE PROSTHETIC RESTORATION	17
<b>FURTHER DOCUMENTATION</b>	<b>18</b>

# GENERAL SYSTEM INFORMATION ON THE CAMLOG® IMPLANT SYSTEM

## THE CAMLOG® IMPLANT SYSTEM

The CAMLOG® Implant System is based on many years of clinical and laboratory experience and is a user-friendly, consistently prosthesis-oriented implant system.

All CAMLOG® products are continually updated to the latest technological standards. The CAMLOG® Implant System is being continuously developed and adapted by the CAMLOG research and development team in collaboration with clinics, universities and dental technicians and therefore stays abreast of the latest developments in technology.

The CAMLOG® Implant System is very well documented scientifically. Numerous studies addressing a number of parameters, e.g., implant surface, time of implantation and/or implant loading, primary stability, connection design or type of suprastructure, support this. The long-term results for the CAMLOG® Implant System are convincing.

## ATTENTION!

The descriptions that follow are not adequate to permit immediate use of the CAMLOG® Implant System. Instruction by an experienced operator in the management of the CAMLOG® Implant System is strongly recommended. CAMLOG® dental implants and abutments should be used only by dentists, physicians, surgeons and dental technicians trained in the system. Appropriate courses and training sessions are regularly offered by CAMLOG. Methodological errors in treatment can result in loss of the implant and significant loss of peri-implant bone.



# SYSTEM INTRODUCTION

## GENERAL GUIDELINES FOR THE MANUFACTURE OF IMPLANT-SUPPORTED PROSTHETICS

Modern implant prosthetics is now an established component of dentistry. The expectations and demands of patients are steadily increasing. Therefore, the ultimate goal of modern implant-supported treatment concepts is for full esthetic, functional, phonetic, and psychosocial rehabilitation. This applies equally to replacements of lost single incisors associated with trauma and the complex rehabilitation of periodontally compromised remaining teeth or the treatment of an edentulous heavily atrophied maxilla and mandible.

Increasingly higher demands for quality and specialization require a multidisciplinary team approach to combine the members acquired knowledge and experience. Modern implant-supported restorations need a high level of attention to detail and clinical experience. This is true equally for the restorative dentist, the surgeon, the dental technician, and the dental office support staff such as the nurse, hygienist, and chair assistant. The CAMLOG team concept takes all of these demands into consideration. The sequence of treatment procedures is structured, and specific procedures are clearly assigned to specific team members once the joint planning phase is complete.

The implant-supported prosthetic restoration should be designed as simple and as safe as possible in regards to planning and fabrication. The required number of implants, as well as their length and diameter are determined based on the restoration planned later and the available bony implant site. The pre-implantation planning should be oriented exclusively to prosthetic needs (backward planning).

The patient is the focus of the implantological restoration. The patients needs and desires must play a part in the fabrication of the prosthetic restoration. This also requires taking into account anatomical relationships and conditions. Natural teeth are attached elastically by the periodontium to the alveolar bone. However, implants are rigidly anchored to the alveolar bone by the ankylotic connection to the bone substance. Mastication forces placed on implant-borne crown and bridge restorations are transferred directly to the bone. For this reason, the mastication forces should be transferred by a possible physiological process in the form of a suitable occlusion design thus supporting the long-term success of the integrated implants.

This can be achieved in the posterior occlusal area with a surface area of approx. 1 mm<sup>2</sup> that allows lateral freedom of movement of approx. 1 mm in habitual intercuspation. This makes it possible for the cusps to glide smoothly between the retrusive contact position (centric occlusion) and the maximum intercuspal position called «freedom in centric». In conjunction with a premolarized forming, overloads can be avoided. Extreme cusp formations should be avoided due to dentition that is too strong and vertical mastication forces affect the implant/antagonist axis preferably physiologically. Guidance functions of crown restorations on individual implants can lead to lateral force affects that are too strong and should be avoided. Appropriate planning should occur (e.g. wax-up) in advance.

## CAMLOG® TUBE-IN-TUBE™ IMPLANT ABUTMENT CONNECTION

All CAMLOG® implants are equipped with the proven Tube-in-Tube™ Implant Abutment Connection and feature three symmetrically arranged grooves (width 0.5 or 0.7 mm, depth 1.2 mm).

CAMLOG® abutments include three cams underneath the implant shoulder support that correspond to the three grooves in the implant/lab analog.

When inserting the abutments, their tubular extension toward the apex affects the simple, easy and safe orientation in the longitudinal axis of the implant/lab analog before the three cams rest on the shoulder of the implant.

The abutment is rotated until tactile engagement of the cams in the grooves of the implant/lab analog. The abutment is then in the final position.

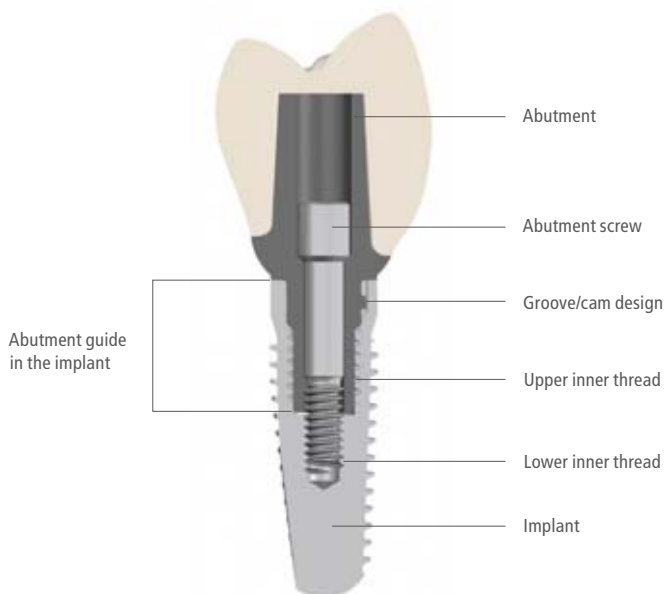

**NEW:** SCREW-LINE implants have square grooves (new inner configuration of the K-Series) in the cylindrical implant neck area.

New SCREW-LINE implants with K article numbers (K-Series) can only be fitted with abutments with K article numbers (K-Series).

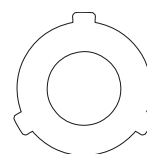
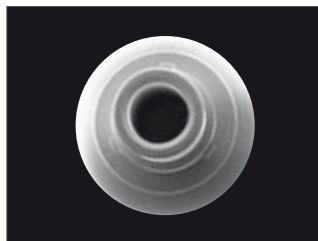
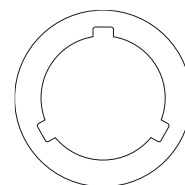
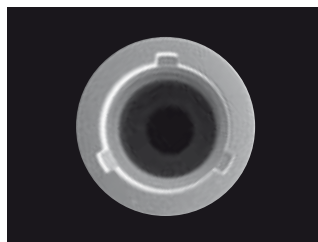

**WHAT DOES NOT WORK ...**

Due to the shortened grooves, the new SCREW-LINE implants with K article numbers (K-Series) can no longer be provided with conventional abutments and impression posts (long cams) with the J article number.

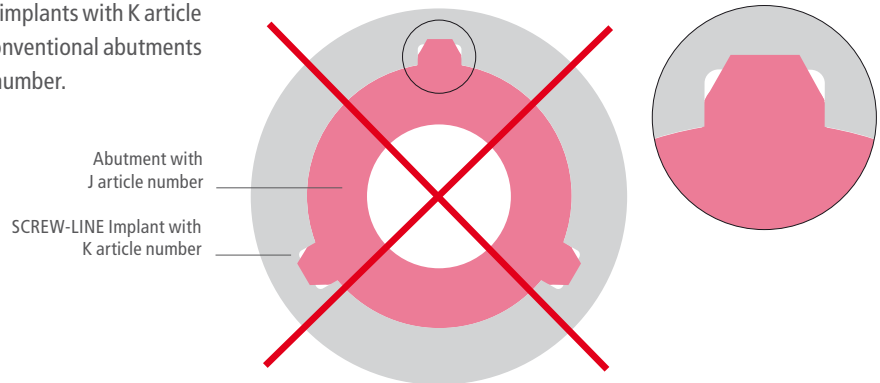

**EXISTING:**

ROOT-LINE, SCREW-CYLINDER-LINE and CYLINDER-LINE implants feature the conventional grooves in the cylindrical implant neck area.

ROOT-LINE, SCREW-CYLINDER-LINE and CYLINDER-LINE implants can be provided with abutments of the K article numbers (K-Series) and abutments with J article numbers (backward compatibility).

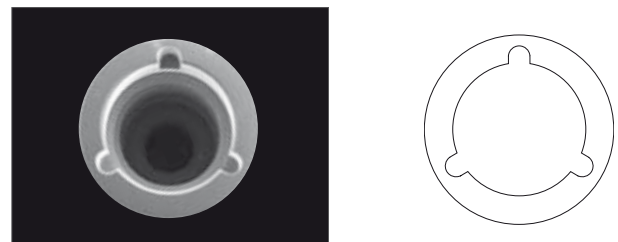

**NEW CAMLOG® ABUTMENTS WITH K ARTICLE NUMBER (K-SERIES)**

As part of continued development of CAMLOG® products, all CAMLOG® abutments will be manufactured with shortened cams and be identified with K article numbers (K-Series). The abutments are adapted to the new SCREW-LINE implants with shortened cams (K-Series). The abutments of the K-Series are also compatible with the implants of the ROOT-LINE, SCREW-CYLINDER-LINE/CYLINDER-LINE.



## CAMLOG COLOR CODING

### COLOR-CODING OF THE SURGICAL AND PROSTHETICAL CAMLOG® PRODUCTS

	COLOR	DIAMETER
	grey	3.3 mm
	yellow	3.8 mm
	red	4.3 mm
	blue	5.0 mm
	green	6.0 mm

#### IMPORTANT NOTE

No components of different diameters should be attached to one another.  
The system components must not be modified.



# PRODUCT DESCRIPTION

## INTRODUCTION

The Logfit® Prosthetic System enables the fabrication of cementable fixed crown and bridge restorations intended for maintenance of CAMLOG® implants in the maxilla and mandible. The Logfit® Prosthetic System consists of prefabricated components precisely matched to one another that standardize the clinical and technical procedure. The result is a lower workload and considerable time savings for the practice and laboratory.

The Logfit® Prosthetic System consists of color-coded Logfit® abutments with two selectable gingival heights (0.8 and 1.5 mm), Logfit® impression caps, Logfit® analogs and burn-out Logfit® plastic copings with and without rotation security for the manufacture of casted crown and bridge structures.



The Logfit® abutment can also be scanned using current dental scanners and the digitally captured geometries used in the fabrication of mesostructures with CAD/CAM techniques.

## LOGFIT® ABUTMENTS

Logfit® abutments are available in gingival heights (GH) 0.8 mm and 1.5 mm and in implant diameters 3.8/4.3/5.0/6.0 mm. They are color-coded according to the diameter of the implant and include an abutment screw.

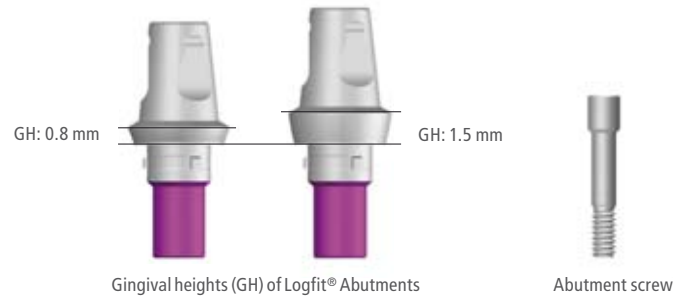

Logfit® abutments are available based on the gingival height in various prosthetic heights.

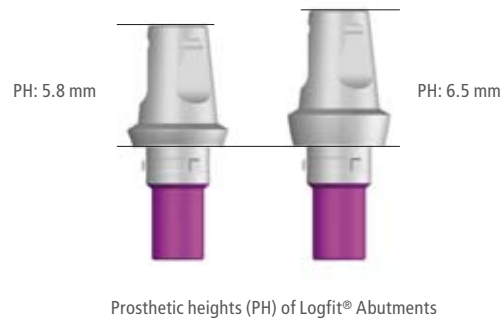

The Logfit® abutment cone has an angle of 6°. The result are bridge structures with implant abutment divergences of up to 12°.

### LOGFIT® ABUTMENT incl. abutment screw (Ti6Al4V)





















Art. No.	K2550.3808	K2550.3815	K2550.4308	K2550.4315	K2550.5008	K2550.5015	K2550.6008	K2550.6015
Ø	3.8	3.8	4.3	4.3	5.0	5.0	6.0	6.0
GH	0.8	1.5	0.8	1.5	0.8	1.5	0.8	1.5
PH	5.8	6.5	5.8	6.5	5.8	6.5	5.8	6.5

GH: Gingival height (in mm)

PH: Prosthetic height (in mm, measured from the implant shoulder support to occlusal abutment edge)

## SYSTEM OVERVIEW

The overview shows the assignment of the individual Logfit® components for the respective worksteps.

Implant diameter	Ø 3.8 mm		Ø 4.3 mm		Ø 5.0 mm		Ø 6.0 mm	
								
Logfit® abutment								
Art. No.	K2550.3808	K2550.3815	K2550.4308	K2550.4315	K2550.5008	K2550.5015	K2550.6008	K2550.6015
GH	0.8	1.5	0.8	1.5	0.8	1.5	0.8	1.5
	Prosthetic diameter 4.8 mm*				Prosthetic diameter 6.5 mm*			
Logfit® impression cap								
Art. No.	J2551.4300				J2551.6000			
Logfit® analog								
Art. No.	J2552.4300				J2552.6000			
Logfit® plastic coping crown								
Art. No.	J2553.4302				J2553.6002			
Logfit® plastic coping bridge								
Art. No.	J2553.4301				J2553.6001			

GH: Gingival height (in mm)

\*Logfit® abutments for implant diameters 3.8 and 4.3 mm have a prosthetic diameter of 4.8 mm and abutments for implant diameters 5.0 and 6.0 mm, a prosthetic diameter of 6.5 mm. The associated components are matched based on this diameter.

# APPLICATION

## SELECTION AND USE OF THE LOGFIT® ABUTMENT

The clinician selects the Logfit® abutment based on the clinical situation on the patient directly. Selecting the abutment gingival height is based on the given mucosal thickness.

To remove any cement residues, the abutment shoulder should not be more than 1.5–2.0 mm subgingivally.

### IMPORTANT NOTE

The products must always be protected from the risk of aspiration during intraoral use.

Clean the internal configuration of the implant after removing the healing cap. The selected Logfit® abutment is inserted in the implant and rotated until tactile engagement of the cams in the grooves of the implant. The abutment is then in the final position.

A screwdriver (hex) and torque wrench are then used to tighten the abutment screw definitively with a torque of **20 Ncm**. To achieve maximum pre-tension on the screws, the abutment screw should be retightened with the same torque after approx. 5 minutes.

We recommend taking a control x-ray to make sure the abutment is correctly seated on the implant.



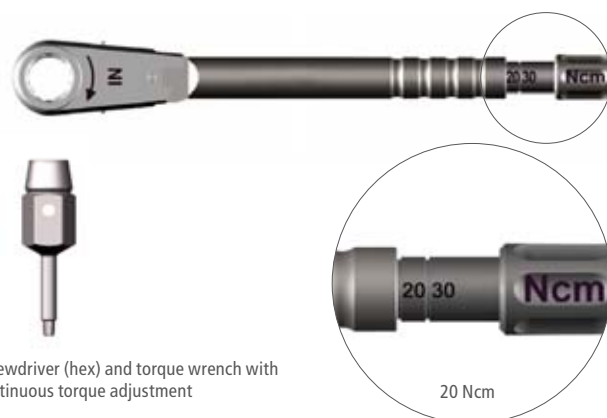

### IMPORTANT NOTE

Logfit® abutments must not be modified. Doing so would disrupt the design of the snap action of the Logfit® impression caps and compromise the matched shape of the Logfit® plastic copings.



## LOGFIT® IMPRESSION TAKING

The Logfit® impression caps are used over the Logfit® abutments directly to take impressions of the oral situation. Impression taking of the abutment diameters 3.8/4.3 mm and 5.0/6.0 mm are taken with a separate Logfit® impression cap.

Art. No.	Article	For implant diameters	
J2551.4300	Logfit® impression cap (POM)	3.8 mm 	4.3 mm 
J2551.6000	Logfit® impression cap (POM)	5.0 mm 	6.0 mm 

The Logfit® impression cap is placed on the Logfit® abutment, turned lightly until the rotation protection interlocks and pressed downward carefully. A detectable locking sensation signals the final position. Three plastic retainers hold the impression cap in position while taking the impression.

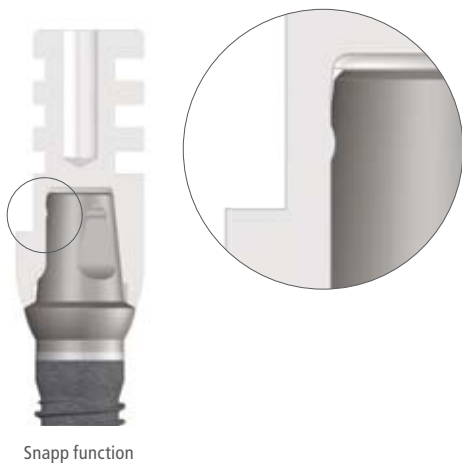

Use a silicone or polyether impression material and a closed tray to take the impression. The impression cap remains in the impression tray after the impression is taken.







After the impression is taken successfully, seal the screw channel of the Logfit® abutment with an easily removable material; the surface should be concave. Logfit® abutments can then be supplied with a temporary restoration in the conventional manner.

**TIP:** To further simplify the workflow, we recommend that you inform the dental laboratory of the implant diameter used.

## LOGFIT® CAST FABRICATION

For cast fabrication, two separate Logfit® analogs are available for abutment diameters 3.8/4.3 mm and 5.0/6.0 mm that are compatible with the specified impression caps.

Art. No.	Article	For implant diameters	
J2552.4300	Logfit® analog (Ti6Al4V)	3.8 mm 	4.3 mm 
J2552.6000	Logfit® analog (Ti6Al4V)	5.0 mm 	6.0 mm 

Insert the appropriate Logfit® analog into the impression cap based on the impression cap used and carefully rotate until the rotation protection interlocks. Then carefully press in the analog until a detectable locking sensation signals the final position. During cast fabrication, the analog is secured in the impression cap by the snap function mechanism.



The impression is cast out with appropriate cast plaster and the analog may not loosen. After curing, the impression is removed and the impression caps remain in the impression.



**TIP:** We recommend fabricating the cast with a gingiva mask. The surrounding gingiva is represented elastically and true to the situation especially for subgingival crown margins and restorations in esthetic areas. An optimal design of the crown contour is easier to achieve.

## FABRICATION OF THE PROSTHETIC RESTORATION

To fabricate the prosthetic restoration, prefabricated burn-out Logfit® plastic copings are available for crowns with rotation protection and for bridges with round inner configuration.

Plastic copings are available for abutment diameters 3.8/4.3 mm and 5.0/6.0 mm and compatible with the Logfit® analogs. The prefabricated plastic copings allow a cement gap of 20–50 µm for casting with a suitable alloy. A prerequisite is compliance with the instructions of the alloy and investment materials manufacturer.











Logfit® plastic coping crown with three antirotational surfaces



Logfit® plastic copying with round inner configuration



Art. No.	Article	For implant diameters	
J2553.4301	Logfit® plastic coping bridge burn-out (POM)	3.8 mm 	4.3 mm 
J2553.4302	Logfit® plastic coping crown burn-out (POM)	3.8 mm 	4.3 mm 
J2553.6001	Logfit® plastic coping bridge burn-out (POM)	5.0 mm 	6.0 mm 
J2553.6002	Logfit® plastic coping crown burn-out (POM)	5.0 mm 	6.0 mm 

Place a Logfit® plastic coping crown that matches the implant diameter on a matching Logfit® analog in the cast and carefully rotate until the rotation protection interlocks. Then carefully press down the plastic coping until it snaps over the O-ring of the analog.

The O-ring ensures appropriate attachment on the analog during the subsequent wax-up of the restoration.

### IMPORTANT NOTE

Logfit® components must not be modified. This would compromise the matched shape of the Logfit® plastic copings to the Logfit® abutments.

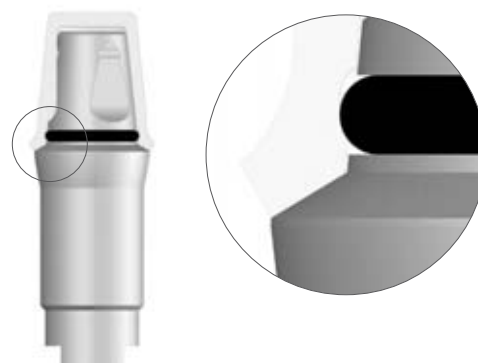

O-ring on the Logfit® analog

### WAX-UP

The framework is waxed up in the usual manner according to the design of the «reduced crown shape». Take care that adequate and uniform ceramic layer can be achieved for the veneering. The minimum wax thickness over the plastic coping should be at least 0.3 mm. Do not cast over the delicate coping edge.

#### IMPORTANT NOTE

When burning out the casting muffle, swelling may occur due to the thermal expansion of the plastic and damage the investment compound in the area of the plastic coping. This can cause investment compound to be included in the casting metal. Therefore, a minimum wax thickness of 0.3 mm should be applied to the plastic coping. When heating, the wax softens first and gives the plastic enough space to expand.



The ideal framework form can be controlled with a previously prepared silicone index.

**TIP:** To prevent non-axial loads and over contouring in the posterior area, we recommend reducing the wax-up to premolar size.

### VERTICAL DIMENSION TO THE THE OCCLUSION LEVEL

Information from implantologists for the length of implants used plays an important role in the prosthetic planning respectively restoration. Loading of the implant-bone interface is a result of the leverage relation generated by osseointegration-related resistance to the prosthesis load arm (equivalent to the supracrestal implant length plus the length of the crown above the implant shoulder). If IL is smaller than CL, then the load must be reduced (e.g. through prosthetic splinting). The length ratio of single crown to implant should be max. 0.8:1.

IL = Implant Length  
CL = Crown Length

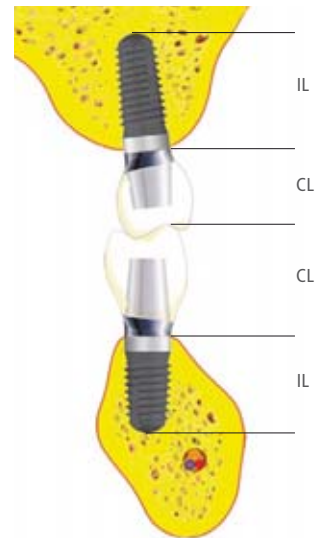



### INVESTMENT, CAST AND DEVESTMENT

The waxed frame work is embedded according to the instruction manual of the muffle system used. We do not recommend the use of a wax wetting agent. However, if wax wetting agents are used, it must be suitable for use with POM plastic components. When embedding, the correct placement of the wax-up framework in the casting muffle is of importance. Volume ratios and pin angles must be selected so that the required temperature for casting is achieved. This is particularly important for voluminous casts.

We recommend phosphate bound investment materials. The manufacturers processing instructions must be observed and the mixing ratios and pre-heating times accurately observed. We recommend not to use any quick heating processes (speed investment compounds). The cast delay time must be kept as brief as possible.

After casting, the cast object must be slowly cooled to room temperature and the object gently devested. We recommend gentle devestment in an ultrasonic bath with waterjet or stripping.

After trimming, the cast object is prepared for ceramic veneering. The ceramic to be used must be compatible with the alloy (observe heat expansion coefficient). The occlusal surface should be designed based on the «Freedom in centric» concept.

### INSERTION AND CEMENTING OF THE PROSTHETIC RESTORATION

Clean and disinfect the prosthetic components prior to insertion. We recommend component sterilization (see also the "Preparation Instructions for the CAMLOG® Implant System", Art. No. J8000.0032). The peri-implant hard and soft tissue situation must allow gapless insertion of the restoration on the Logfit® abutment.

We recommend phosphate and carboxylate cements for the final cementation. Manufacture instructions must be observed. To avoid an air cushion, only a thin layer of cement should be brushed into the restoration.

#### IMPORTANT NOTE

Cement residues in the sulcus must be carefully removed.



# FURTHER DOCUMENTATION

Further information about CAMLOG® products is available in the following documentations:

- Current CAMLOG product catalog
- Work instructions
- Preparation instruction
- Instruction manuals (included with CAMLOG® products as package inserts)
- [www.camlog.com](http://www.camlog.com)

## CROWN AND BRIDGE RESTORATIONS WITH THE CAMLOG® IMPLANT SYSTEM

Information about additional prosthetic restoration options for the CAMLOG® Implant System is available in the «Crown and and bridge restorations with the CAMLOG® Implant System» work instruction:

- Planning of the Prosthetic Restoration
- Temporary Abutment
- Esthomic® Line of Abutments
- Universal Abutment
- Gold-Plastic Abutment
- Titanium Base CAD/CAM
- Ceramic Abutment



#### **TRADE NAMES AND COPYRIGHT**

Protected trade name (trademarks) are not specially indicated. The absence of such notes may not be interpreted to mean that a trade name is unregistered. This document, including all its parts, is protected by copyright. Any use beyond the restricted limits of the copyright law without the agreement of CAMLOG Biotechnologies AG is not permissible and is punishable by law.



**HEADQUARTERS**

CAMLOG Biotechnologies AG | Margarethenstrasse 38 | CH-4053 Basel  
Phone +41 61 565 41 00 | Fax +41 61 565 41 01 | info@camlog.com | www.camlog.com

Manufacturer of CAMLOG® products: ALTATEC GmbH, Maybachstraße 5, D-71299 Wimsheim

