

a perfect fit™

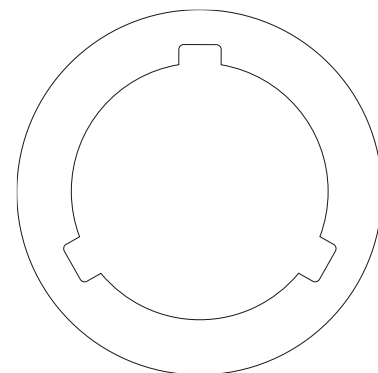

HYBRID RESTORATIONS WITH THE CAMLOG® IMPLANT SYSTEM



Basic Information

CAMLOG Cast Fabrication

CAMLOG Bite Registration

CAMLOG Bar Restorations

CAMLOG® Ball Abutment Anchoring System

Locator® Anchoring System

Double Crown Restorations

camlog

TABLE OF CONTENTS

GENERAL SYSTEM INFORMATION ABOUT THE CAMLOG® IMPLANT SYSTEM	4
SYSTEM INTRODUCTION	5
GENERAL GUIDELINES FOR THE FABRICATION OF IMPLANT-SUPPORTED PROSTHETICS	5
RECALL	5
CAMLOG® IMPLANT ABUTMENT CONNECTION	6
CAMLOG COLOR-CODING	9
PLANNING OF THE PROSTHETIC RESTORATION	10
CAMLOG® IMPRESSION TAKING OPTIONS	12
CAMLOG® CAST FABRICATION	13
CAMLOG® BITE REGISTRATION POSTS	17
BAR RESTORATIONS	21
INTRODUCTION	21
PRODUCT DESCRIPTION	21
CAMLOG® IMPRESSION TAKING OPTIONS	23
IMPRESSION TAKING OVER CAMLOG® BAR ABUTMENTS	23
IMPRESSION TAKING OVER THE CAMLOG® IMPLANT SHOULDER	27
CAST BAR CONSTRUCTIONS	28
BASE FOR BAR ABUTMENT, BURN-OUT	28
SLEEVE FOR TITANIUM BONDING BASE, BURN-OUT (PASSIVE-FIT)	30
BASE FOR BAR ABUTMENT, CAST-ON	32
BASE FOR BAR ABUTMENT, LASER-WELDABLE	34
BASE FOR BAR ABUTMENT, SOLDERABLE	35
RELINING OF A BAR-SUPPORTED FULL DENTURE	37
BALL ABUTMENT ANCHORING SYSTEM	39
INTRODUCTION	39
PRODUCT DESCRIPTION	39
CAMLOG® IMPRESSION OPTIONS	42
FABRICATION OF A NEW BALL-RETAINED FULL DENTURE WITH INTEGRATED METAL REINFORCEMENT	43
BROADENING OF AN EXISTING FULL DENTURE INTO A BALL ABUTMENT-RETAINED FULL DENTURE	47
RELINING OF A BALL ABUTMENT-RETAINED FULL DENTURE	50
FOLLOW-UP/RECALL	51

LOCATOR® ANCHORING SYSTEM	52
PRODUCT DESCRIPTION	52
PROCESSING	55
INSERTION OF THE CAMLOG® LOCATOR® ABUTMENT	55
FABRICATION OF A NEW LOCATOR®-RETAINED FULL DENTURE	56
IMPRESSION TAKING	56
CAST FABRICATION	57
INTEGRATION OF THE COLORED REPLACEMENT MALES	58
CONVERTING AN EXISTING FULL DENTURE INTO A LOCATOR®-RETAINED FULL DENTURE	59
CONVERTING AN EXISTING FULL DENTURE INTO A LOCATOR®-RETAINED FULL DENTURE IN THE DENTAL PRACTICE	60
RELINING OF A LOCATOR®-RETAINED FULL DENTURE	62
DOUBLE CROWN RESTORATIONS	63
INTRODUCTION	63
PRODUCT DESCRIPTION	63
IMPRESSION TAKING AND CAST FABRICATION	63
CAST FABRICATION FOR MILLING TECHNIQUE	63
CAMLOG® UNIVERSAL ABUTMENT AND CAMLOG® UNIVERSAL ABUTMENT PS FOR PLATFORM SWITCHING	65
CAMLOG® TELESCOPE ABUTMENT	65
CAMLOG® GOLD-PLASTIC ABUTMENT	69
ACCESSORIES AND PROSTHETIC INSTRUMENTS	73
MATERIALS	74
FURTHER DOCUMENTATION	75

GENERAL SYSTEM INFORMATION ABOUT THE CAMLOG® IMPLANT SYSTEM

THE CAMLOG® IMPLANT SYSTEM

The CAMLOG® Implant System is based on years of clinical and laboratory experience and is a user-friendly, consistent prosthetically oriented implant system.

The CAMLOG® Implant System is being continuously developed and adapted to the state of technology by the internal research and development team in collaboration with clinics, universities and dental technicians.

The CAMLOG® Implant System is well documented scientifically. Numerous studies based on various parameters, e. g. implant surface, time of implantation and/or implant loading, primary stability, connection design or type of suprastructure, support this. The long-term outcomes for the CAMLOG® Implant System are persuasive.

IMPORTANT NOTE

The descriptions that follow are not adequate to permit immediate use of the CAMLOG® Implant System. Instruction by a surgeon experienced in using the CAMLOG® Implant System is strongly recommended. CAMLOG® dental implants and abutments should only be used by dentists, physicians, surgeons and dental technicians who have been trained in using the system. CAMLOG regularly offers relevant courses and training sessions. Methodical errors made during the treatment can result in loss of the implant and significant loss of the peri-implant bone.



SYSTEM INTRODUCTION

GENERAL GUIDELINES FOR THE FABRICATION OF IMPLANT-SUPPORTED PROSTHETICS

Modern implant prosthetics is now an established component of dentistry. The expectations and demands of patients are steadily increasing. Therefore, the ultimate goal of modern implant-supported treatment concepts is for full esthetic, functional, phonetic, and psychosocial rehabilitation. This applies equally to replacements of lost single incisors associated with trauma and the complex rehabilitation of periodontally compromised remaining teeth or the treatment of an edentulous heavily atrophied maxilla and mandible.

Increasingly higher demands for quality and specialization require a multidisciplinary team approach to combine the members acquired knowledge and experience. Modern implant-supported restorations need a high level of attention to detail and clinical experience. This is true equally for the restorative dentist, the surgeon, the dental technician, and the dental office support staff such as the nurse, hygienist, and chair assistant. The CAMLOG team concept takes all of these demands into consideration. The sequence of treatment procedures is structured, and specific procedures are clearly assigned to specific team members once the joint planning phase is complete.

The implant-supported prosthetic restoration should be designed as simple and as safe as possible in regards to planning and fabrication. The required number of implants, as well as their length and diameter are determined based on the restoration planned later and the available bony implant site. The preimplantation planning should be oriented exclusively to prosthetic needs (backward planning).

The patient is the focus of the implantological restoration. The patients needs and desires must play a part in the fabrication of the prosthetic restoration. This also requires taking into account anatomical relationships and conditions. Natural teeth are attached elastically by the periodontium to the alveolar bone. However, implants are rigidly anchored to the alveolar bone by the ankylotic connection to the bone substance. Mastication forces placed on implant-borne crown and bridge restorations are transferred directly to the bone. For this reason, the mastication forces should be transferred by a possible physiological process in the form of a suitable occlusion design thus supporting the long-term success of the integrated implants.

This can be achieved in the posterior occlusal area with a surface area of approx. 1 mm² that allows lateral freedom of movement of approx. 1 mm in habitual intercuspatation. This makes it possible for the cusps to glide smoothly between the retrusive contact position (centric occlusion) and the maximum intercuspal position called «freedom in centric». In conjunction

with a premolarized forming, overloads can be avoided. Extreme cusp formations should be avoided due to dentition that is too strong and vertical mastication forces affect the implant/antagonist axis preferably physiologically. Guidance functions of crown restorations on individual implants can lead to lateral force affects that are too strong and should be avoided. Appropriate planning (e.g. wax-up) is therefore essential.

RECALL

Resilient supported full dentures with retention devices should be regularly checked in three-month intervals after insertion. When harmful movements of the prosthesis occur, they can be eliminated promptly by through appropriate measures (occlusion check, activation / replacement of the matrices, relining). Patients with inadequate oral hygiene are re-motivated and instructed again as part of oral hygiene and denture care. For patients with good oral hygiene, the intervals between the functional and hygiene checks can be extended.

SYSTEM INTRODUCTION

CAMLOG® IMPLANT ABUTMENT CONNECTION

Various CAMLOG® abutments for anchoring of an implant-retained full denture with varying geometries are available for the CAMLOG® Implant System. The abutments differ in the apical area with two different types of connection.

CAMLOG® BAR, BALL AND LOCATOR® ABUTMENTS

CAMLOG® bar, ball and Locator® abutments have a thread in the apical area that engages the upper respectively lower (for implants with Ø 3.3 mm) inner thread of the CAMLOG® lab analog respectively CAMLOG® implant. The abutments are screwed into the CAMLOG® implant with a defined torque using the corresponding drivers and close flush with the implant shoulder.



Due to the design of the screw connection, the abutments do not have cams.

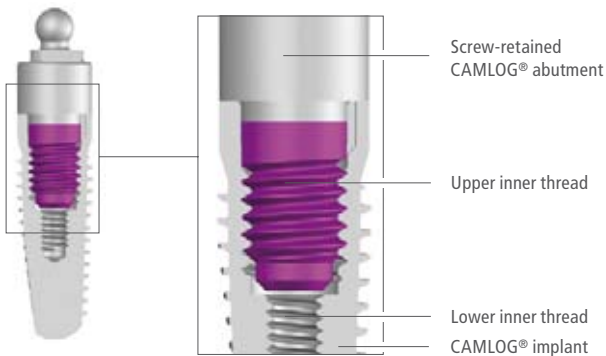

Example: CAMLOG® ball abutment (Ø 4.3 mm) in a CAMLOG® SCREW-LINE implant

CAMLOG® UNIVERSAL, TELESCOPE AND GOLD-PLASTIC ABUTMENTS

CAMLOG® universal, telescope and gold-plastic abutments can be used to fabricate double crown anchoring. They have the CAMLOG® Tube-in-Tube™ implant abutment connection in the apical area and feature three symmetrically arranged cams.

When inserting the CAMLOG® abutments, their tubular extension toward the apex affects the simple, easy and safe orientation in the longitudinal axis of the CAMLOG® implant/CAMLOG® lab analog before the three cams rest on the shoulder of the implant.

The abutment is rotated until tactile engagement of the cams in the grooves of the implant/lab analog. The abutment is then in the final position. A screwdriver (hex) is used to fix the CAMLOG® abutment screw devin- itely with a defined torque.

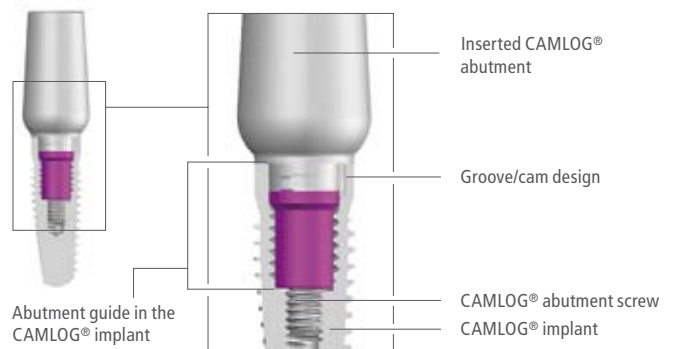
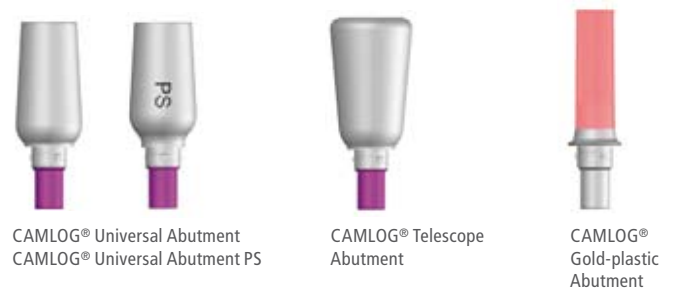

Example: CAMLOG® universal abutment (Ø 4.3 mm) in a SCREW-LINE implant

SYSTEM INTRODUCTION

CAMLOG® UNIVERSAL ABUTMENT PS FOR PLATFORM SWITCHING (K-SERIES)

The Platform Switching option is used to support the hard and soft tissue in esthetic regions. Due to the horizontally reduced diameter of the CAMLOG® abutment PS in relationship to the implant diameter, the implant-abutment interface on the implant shoulder is shifted towards the middle of the implant. This makes it possible to adapt soft tissue over the implant shoulder during the prosthetic restoration.

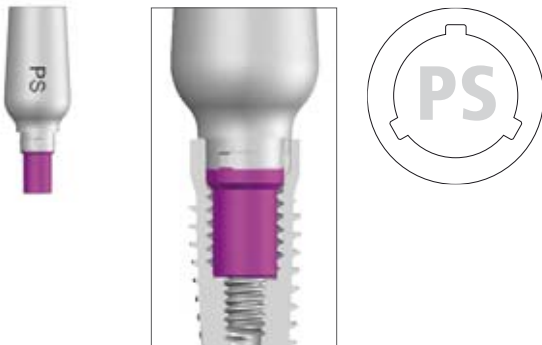

CAMLOG® Universal Abutment PS for Platform Switching (Ø 4.3 mm)
in a CAMLOG® SCREW-LINE implant of the K-Series.

IMPORTANT NOTES

- All prosthetic components for platform switching have the PS label and K article number (K-Series).
- The platform switching option for double crowns is only possible with the CAMLOG® universal abutments PS on CAMLOG® SCREW-LINE implants (K-Series).
- CAMLOG® universal, telescope and gold-plastic abutments with J article number are not compatible with CAMLOG® SCREW-LINE implants with the K article number (K-Series).

CAMLOG COLOR-CODING

To ensure that the correct lab analogs are used for the impression posts, the prosthetic components are color-coded to match the implant diameters.

You should make sure to use and connect only lab analogs and prosthetic components of the same diameter (by color-coding). No components of different diameters should be joined to one another.

COLOR-CODING OF THE SURGICAL AND PROSTHETICAL CAMLOG® PRODUCTS

	COLOR	DIAMETER
	gray	3.3 mm
	yellow	3.8 mm
	red	4.3 mm
	blue	5.0 mm
	green	6.0 mm

PLANNING OF THE PROSTHETIC RESTORATION

INTRODUCTION

Modern implant prosthetics is planned by working back from the desired therapy goal; this is referred to as "backward planning." It applies particularly to pre-implantation augmentation procedures to restore sufficient bony structure to allow placement of implants in the optimal prosthetic position.

The restoration of function, phonetics and enabling good hygienic potential of the prosthesis in an edentulous arch require prosthetically oriented implant positioning and dimensioning, which the dental technician can define on the basis of the specific oral situation with a wax-up/set-up. The prosthetic design and the required implant position(s), axial alignment(s) and implant-supported anchorage options are planned and selected by the dentist and dental technician working closely together. This requires both to be fully informed of the treatment options.

DIAGNOSTIC CASTS, WAX-UP/SET-UP

Diagnostic casts are used to represent the oral anatomical features such as the contour and size of the alveolar ridge, vestibular folds, oral bands and retromolar areas. The diagnostic casts are mounted in an adjustable articulator with the aid of an arbitrary face bow and centric registration, making it possible to represent the planned prosthetic restoration in the form of a wax set-up. The planned prosthetic result, the planned implant positions and the contour of the alveolar ridge are taken into account.

DIMENSION CONTROL WITH SILICONE INDEX

A silicone index created from a wax set-up is used to represent the space requirement for the planned full denture restoration on the diagnostic cast. The index should embrace the tooth arch from oral to vestibular. After curing, the index is divided along the incisal or occlusal midline. After removing the set-up, the corresponding silicone index half (buccal or palatal/lingual half) shows the space requirement for the restoration. The silicone index can then be used to determine optimal implant positioning, axis alignments and anchoring systems.

ARCH RELATIONS

The arch relations has effects on the load direction and therefore on the axial alignment of the implants. This is particularly important with cross-bite situations.

X-RAY/DRILLING TEMPLATE WITH CT-TUBES FOR CT PLANNING

In a planning template fabricated on the diagnostic cast, CT-tubes are integrated at the ideal implant position and are used as reference positions in the x-ray image. The CT-tubes have two parts, and the titanium material does not cause any scattering of rays in the CT/DVT. The lower section is polymerized into the template. The upper section is pluggable. The entire CT-tube is used for the radiological diagnostics; the upper section can be removed for surgery. Depending on the software used for the evaluation, titanium CT-tubes or other radio-opaque positioning elements (e.g. steel, barium sulfate) are integrated for the CT/DVT-supported planning. Placing the CT-tubes directly on the mucosa makes it possible to determine density in the CT/DVT. The documentation included with these systems contains more information on this topic.

As an alternative to the drilling template with CT-tubes for CT planning, a drilling template can be fabricated with the CAMLOG® Guide System that is used for template-guided preparation of the implant bed and for insertion of SCREW-LINE implants CAMLOG® Guide. Further information is available in the "CAMLOG® Guide System" working instructions, Art. No. J8000.0107.

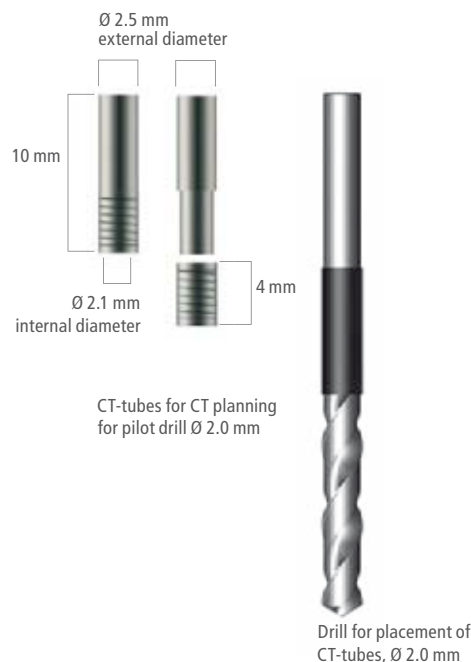

ANCHORING OPTIONS

In consideration of the previous prosthetic planning, the anchoring option with CAMLOG® bar, ball and Locator® abutments or with CAMLOG® abutments for double crown restorations should be sought in collaboration with the dentist and dental technician.

The previously prepared silicone index is used to select the suitable CAMLOG® abutment on the cast. Implant axis, length, diameter and gingival height must be taken into account.

RECOMMENDED INDICATIONS FOR THE CAMLOG® ABUTMENT TYPES

CAMLOG® BAR ABUTMENT

Anchoring of implant-supported full dentures for the edentulous maxilla and mandible on 2, 4 or more CAMLOG® implants. Prefabricated or customized bar constructions.



CAMLOG® BALL ABUTMENT

Resilient anchoring of implant-retained full dentures for the edentulous maxilla and mandible on 2 CAMLOG® implants to secure a tangential rotation axis. Anchoring of implant-supported full dentures for the edentulous maxilla and mandible on 4 CAMLOG® implants.



CAMLOG® LOCATOR® ABUTMENT

Resilient anchoring of implant-supported full dentures for the edentulous maxilla and mandible on CAMLOG® implants.



CAMLOG® UNIVERSAL ABUTMENT

Double crown anchoring of implant-supported full dentures for the edentulous maxilla and mandible on CAMLOG® implants.



CAMLOG® TELESCOPE ABUTMENT

Double crown anchoring of implant-supported full dentures for the edentulous maxilla and mandible on CAMLOG® implants to offset large angulation corrections in the case of disparallel-placed implants.



CAMLOG® GOLD-PLASTIC ABUTMENT

Double crown anchoring of implant-supported full dentures for the edentulous maxilla and mandible on CAMLOG® implants.



CAMLOG® IMPRESSION TAKING OPTIONS

IMPRESSION TAKING DIRECTLY OVER THE CAMLOG® IMPLANT SHOULDER

With this method, the impression is taken over the CAMLOG® implant shoulder directly with a color-coded CAMLOG® impression post, open or closed tray. The impression posts are equipped with a fixing screw that is tightened by hand on the implant using a screwdriver (hex).



NOTE

Taking the impression directly over the CAMLOG® implant shoulder using a CAMLOG® impression post, open and/or closed tray, requires that the cast be fabricated using a CAMLOG® lab analog of the same color.

CAMLOG® IMPRESSION POSTS, OPEN TRAY

ART. NO.	K2121.3300	K2121.3800	K2121.4300	K2121.5000	K2121.6000
					

CAMLOG® IMPRESSION POSTS PS FOR PLATFORM SWITCHING, OPEN TRAY

ART. NO.	K2119.3800	K2119.4300	K2119.5000	K2119.6000
				

The CAMLOG® impression posts, open tray, remain in the impression.

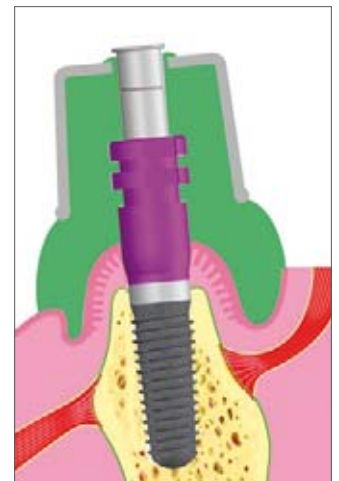

CAMLOG® IMPRESSION POSTS, CLOSED TRAY, incl. impression cap and bite registration cap

ART. NO.	K2110.3300	K2110.3800	K2110.4300	K2110.5000	K2110.6000
					

CAMLOG® IMPRESSION POSTS PS FOR PLATFORM SWITCHING, CLOSED TRAY

ART. NO.	K2109.3800	K2109.4300	K2109.5000	K2109.6000
				

The impression posts are connected with the impression caps.

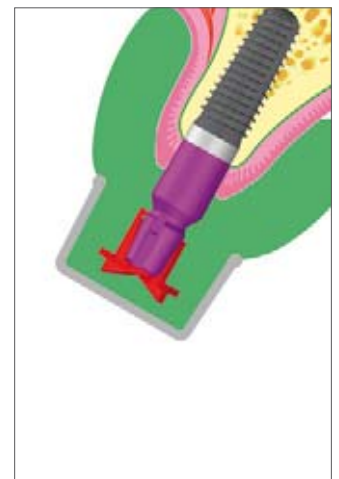

CAMLOG® impression posts, open and closed tray, are compatible with the CAMLOG® SCREW-LINE and CAMLOG® ROOT-LINE implants.

Detailed information about impression taking with CAMLOG® impression posts is available in the working instruction "Impression taking, bite registration and temporary restoration on CAMLOG® implants", Art. No. J8000.0065.

NOTE





For double crown restorations with CAMLOG® universal abutments PS, the impression is taken with CAMLOG® impression posts PS, open or closed tray.

CAMLOG® CAST FABRICATION

CAST FABRICATION WITH THE CAMLOG® LAB ANALOG

The CAMLOG® lab analog is then used for cast fabrication. The CAMLOG® lab analog is attached to the CAMLOG® impression post, open or closed tray, and the fixing screw is hand-tightened using a screwdriver (hex).

CAMLOG® LAB ANALOG

ART. NO.	J3010.3300	J3010.3800	J3010.4300	J3010.5000	J3010.6000
					



CAMLOG® lab analogs have a retention element apically

CAST FABRICATION, CLOSED TRAY

PREPARATION

After the impression is taken, the impression cap remains in the impression.

In the dental laboratory, the CAMLOG® impression post, closed tray, is attached with the corresponding CAMLOG® lab analog (note proper seating).

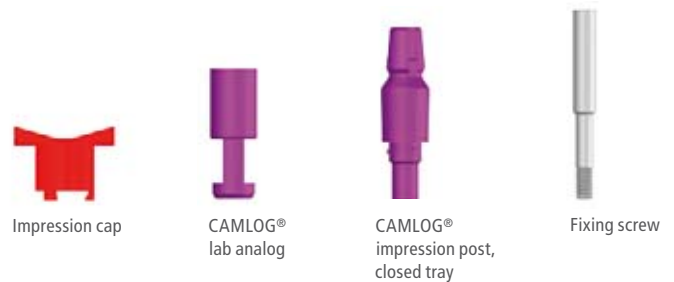

A screwdriver (hex) is used to hand-tighten the fixing screw.



The components are repositioned in the impression caps. Make sure that the grooves correctly engage in the impression cap. Do not use bonding material!

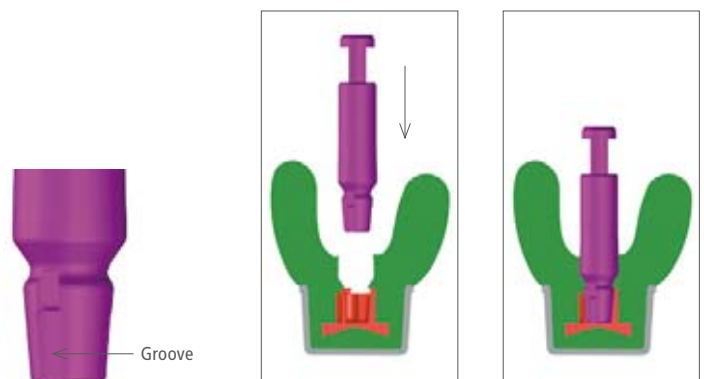

CAMLOG® CAST FABRICATION

CAST FABRICATION

The impression is cast with suitable model material and the impression posts may not loosen. After curing, the impression is removed and the impression posts loosened from the lab analogs.

TIP: We recommend that you fabricate the cast with a gingival mask. The surrounding gingiva is represented true to the situation especially for sub-gingival crown margins and restorations in esthetic areas. An optimal design of the crown contour is easier to achieve.

TIP: After removing the impression, the bite registration caps can be installed on the impression posts in the cast for mounting. The bite registration taken before the impression can be placed on the caps and the cast mounted.

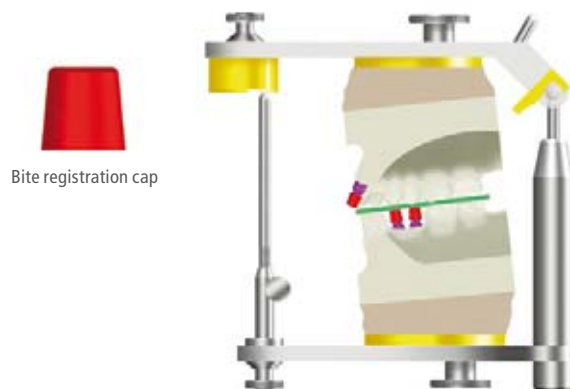
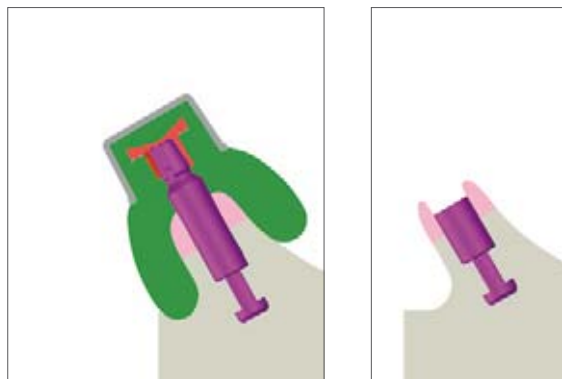

NOTE

Cast fabrication and bite registration with the impression posts, closed tray, and impression posts PS, closed tray, is identical.



CAST FABRICATION, OPEN TRAY

PREPARATION

After the impression is taken, the CAMLOG® impression posts, open tray, remain in the impression.

In the dental laboratory, the lab analogs corresponding to the diameters are attached to the impression posts, open tray (note proper seating). A screwdriver (hex) is used to hand-tighten the fixing screw.

CAST FABRICATION

The impression is cast with appropriate model material. After curing, the impression is removed and the impression posts loosened from the lab analogs.

TIP: We recommend that you fabricate the cast with a gingival mask. The surrounding gingiva is represented true to the situation especially for sub-gingival crown margins and restorations in esthetic areas. An optimal design of the crown contour is easier to achieve.

NOTE

Cast fabrication with the impression posts, open tray, and impression posts PS, open tray, is identical.

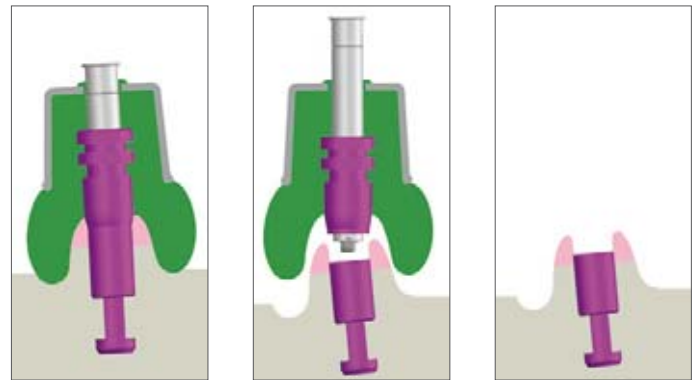
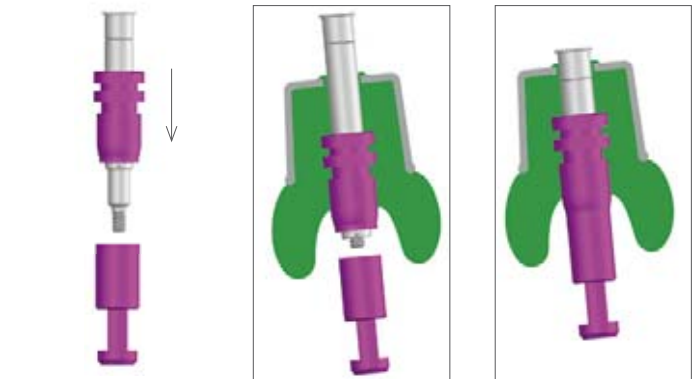
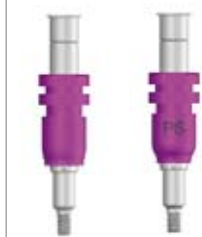

Finished working cast

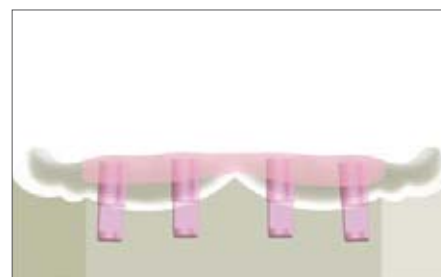

CAMLOG® CAST FABRICATION

ACCESSORIES

REAMER FOR CAST CONDITIONING

If no gingival mask was created during cast fabrication, the cervical implant neck area can be reworked with special plaster reamers. The milling profile exposes the lab analog shoulder to ensure the gapless seat of the abutment.

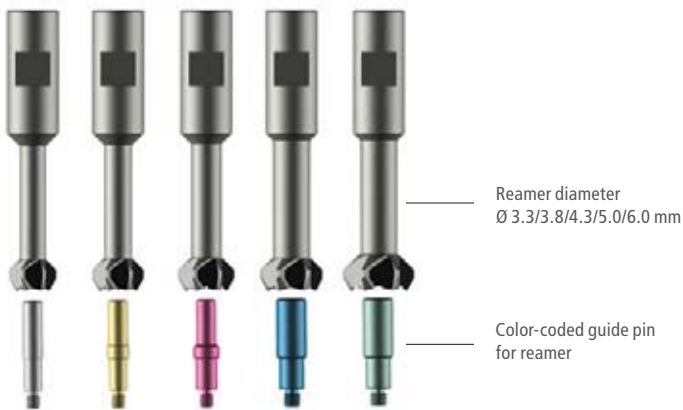

After fabricating the cast, the impression posts are removed. The abutment cannot be placed and plaster must be removed in the cervical area.

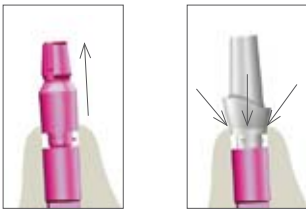

The reamer is inserted in the universal holder. After screwing in the guide pin, the reamer is moved over this and the plaster milled off in a clockwise rotation.



Once lowered completely, the reamer lies on the lab analog shoulder.

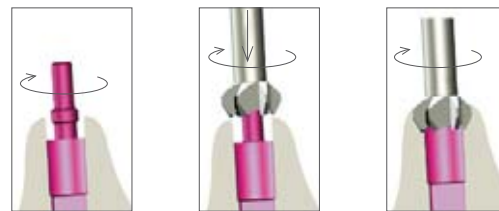

After unscrewing the guide pin, the abutment is inserted into the lab analog.



CAMLOG®

BITE REGISTRATION POSTS

INTRODUCTION

Color-coded CAMLOG® bite registration posts are available for all CAMLOG implant diameters for accurate implant-supported measurement of arch relations and their transfer to the cast situations. The posts include a bite registration cap and an integrated fixing screw.

There are two options for taking the bite registration:

- Option A. Bite registration with mounted bite registration caps
- Option B. Bite registration with splinted bite register without caps

The CAMLOG® bite registration posts have a prosthetic height of 8.1 mm and are suitable for limited occlusal space conditions. A shortened post/implant connection in comparison to the abutment and impression post connection make the use of splinted bite registration posts with implant abutment divergences of up to 20° possible.

The CAMLOG® bite registration posts are tapered apically in the area of the shoulder support and are also suitable for the platform switching option (not for implant diameter 3.3 mm).

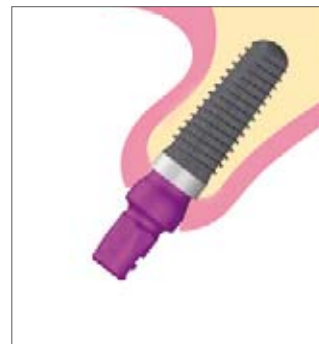
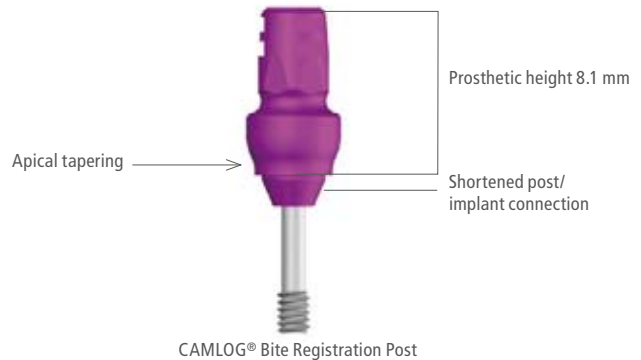

CAMLOG® BITE REGISTRATION POST INCL. BITE REGISTRATION CAP

Art. No.	J2140.3300	J2140.3800*	J2140.4300*	J2140.5000*	J2140.6000*
CAMLOG® bite registration post incl. fixing screw and cap					
For implant diameters	3.3 mm	3.8 mm	4.3 mm	5.0 mm	6.0 mm
PH	8.1 mm	8.1 mm	8.1 mm	8.1 mm	8.1 mm

PH: Prosthetic height

*Note: The bite registration posts with diameter 3.8/4.3/5.0/6.0 mm can also be used for the platform switching option.

REPLACEMENT BITE REGISTRATION CAP

Art. No.	J2112.3300	J2112.3800	J2112.4300	J2112.5000	J2112.6000
Bite registration cap (5 units)					
For implant diameters	3.3 mm	3.8 mm	4.3 mm	5.0 mm	6.0 mm

IMPORTANT NOTE

All components for implant-supported bite registration on CAMLOG® implants are for single use only and must not be modified.

CAMLOG®

BITE REGISTRATION POSTS

USE

Implant-supported measurement of the arch relations and their transfer to the cast situation may be carried out using CAMLOG® bite registration posts with mounted bite registration caps or splinted bite registration posts as a one-piece bite register.

OPTION A.

BITE REGISTRATION WITH MOUNTED BITE REGISTRATION CAPS

The bite registration posts are placed in the previously cleaned implants and a screwdriver (hex) is used to hand-tighten the fixing screws.



The bite registration caps are placed on the bite registration posts based on the color code and the occlusion is checked. Correct seating is indicated by a perceptible locking feel.

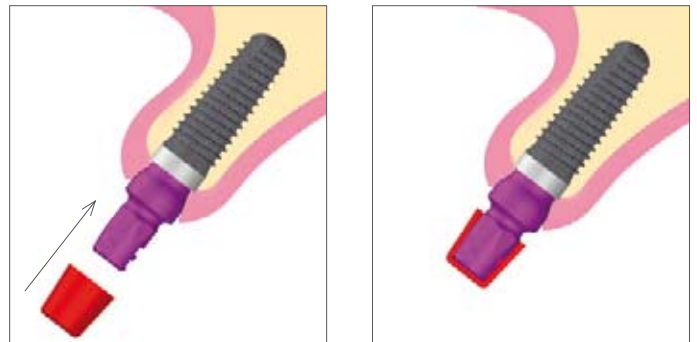

It follows the registration of the arch relations with usual standard materials. The caps should not be allowed to bond to the register.



Remove the bite register, the bite registration caps and the bite registration posts (by loosening the fixing screws) and give all to the dental laboratory. Screw in the bite registration posts into the color-coded lab analogs in the cast and mount the bite registration caps in the final position. Place the bite registration on the caps. Connect the bite registration to the opposing jaw cast and mount the casts in an articulator.

TIP: If bite registration posts cannot be used due to limited space conditions (to prevent bite elevation), a healing cap, cylindrical, height 6.0 mm, may be used. Record the diameter, the position, and the height of the healing cap on the information work sheet and deliver it with the corresponding healing cap to the dental laboratory.

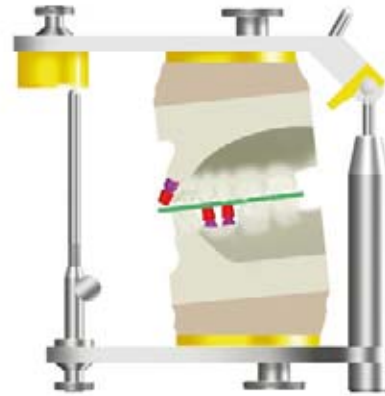

OPTION B.

BITE REGISTRATION WITH SPLINTED BITE REGISTER

After taking the impression and fabricating the cast, fix the CAMLOG® bite registration posts in the lab analog and fabricate a bite register splinted with the posts on the working cast. Coat and connect the bite registration posts with a suitable plastic. Do not cover the fixing screws.

TIP: To avoid distortion stress with larger restorations (edentulous jaw, large gaps), we recommend disconnecting the register between the implant pillars and then reconnecting in the mouth with suitable plastic after attaching to the implants.

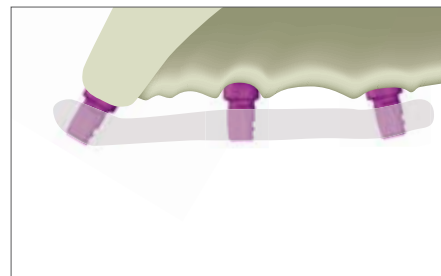
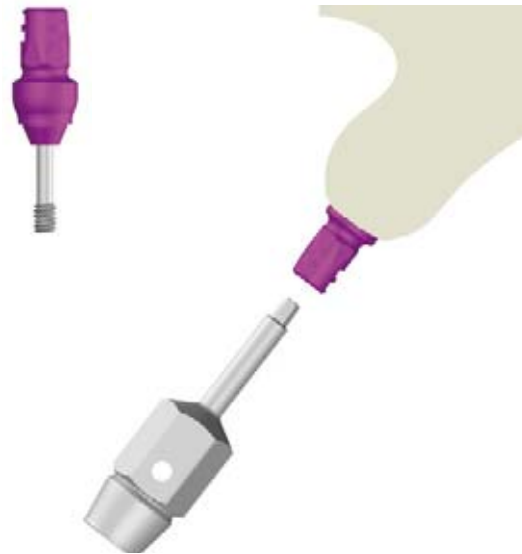

CAMLOG®

BITE REGISTRATION POSTS

Once the register has been created, it is inserted in the mouth, a screwdriver (hex) is used to hand-tighten the fixing screws and the occlusion is checked.

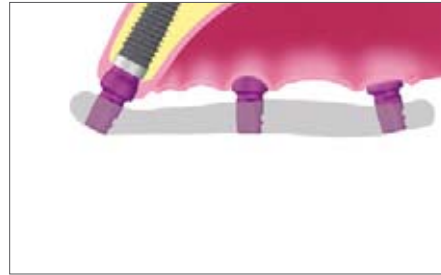

It follows the registration of the arch relations with usual standard materials.



Loosen the fixing screws after curing. To safely remove the bite register, extract the screws from the posts to the stop position. Remove the bite register with the integrated bite registration posts and give it to the dental laboratory.

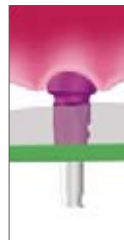

Fixing screw extracted to the stop position

Mount the bite register with integrated bite registration posts on the lab analogs in the cast and screw on. Connect the bite registration to the opposing jaw cast and mount the casts in an articulator.

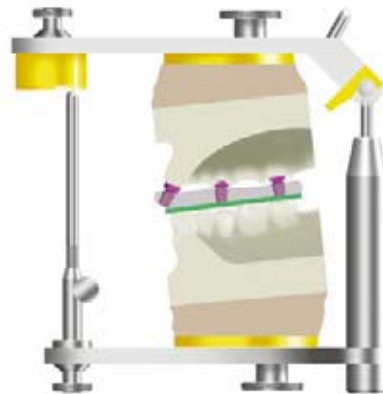

BAR RESTORATIONS

INTRODUCTION

In implantological hybrid prosthetics, bar restorations represent stable implant-connecting designs; a hybrid prosthesis can be securely anchored.

TASKS OF A BAR RESTORATION

- Protecting the prosthesis against shearing and lifting forces
- Shear distribution
- Stabilization and primary splinting of the implants
- Resilience compensation through degrees of freedom

The CAMLOG® bar abutment offers extensive options for fabrication of prefabricated and custom-milled bars because of the wide variety of components available:

PREFABRICATED TITANIUM OR GOLD BAR

Laser-welded bar version with prefabricated titanium bar bases and bar elements or soldered bar version with prefabricated gold bar bases and bar elements.

CUSTOM-CAST/MILLED BAR

Cast bar version with prefabricated bar bases and bar elements made of burn-out plastic for solid casting technology.

BONDED BAR CONSTRUCTION (PASSIVE FIT)

Bonded bar construction with prefabricated bar sleeves made of burn-out plastic for casting technology and titanium bonding base. The Passive Fit System provides the option of fixing cast bars on the implants that are absolutely tension-free.

PRODUCT DESCRIPTION

CAMLOG® bar abutments are available for all CAMLOG® implant diameters in various gingival heights.

CAMLOG® BAR ABUTMENT FOR IMPLANT DIAMETER 3.3 MM

ART. NO.	J2255.3305	J2255.3320
----------	------------	------------

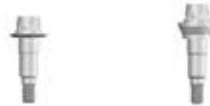

GH	0.5 mm	2.0 mm
----	--------	--------

CAMLOG® BAR ABUTMENT FOR IMPLANT DIAMETER 3.8 MM

ART. NO.	J2255.3805	J2255.3820	J2255.3840
----------	------------	------------	------------



GH	0.5 mm	2.0 mm	4.0 mm
----	--------	--------	--------

CAMLOG® BAR ABUTMENT FOR IMPLANT DIAMETER 4.3 MM

ART. NO.	J2255.4305	J2255.4320	J2255.4340
----------	------------	------------	------------



GH	0.5 mm	2.0 mm	4.0 mm
----	--------	--------	--------

CAMLOG® BAR ABUTMENT FOR IMPLANT DIAMETER 5.0 MM

ART. NO.	J2255.5005	J2255.5020	J2255.5040
----------	------------	------------	------------



GH	0.5 mm	2.0 mm	4.0 mm
----	--------	--------	--------

CAMLOG® BAR ABUTMENT FOR IMPLANT DIAMETER 6.0 MM

ART. NO.	J2255.6005	J2255.6020	J2255.6040
----------	------------	------------	------------



GH	0.5 mm	2.0 mm	4.0 mm
----	--------	--------	--------

GH: Gingival height

BAR RESTORATIONS





Gingival heights from the implant shoulder support to the bar abutment plateau



The gingival height is the distance from the bar abutment plateau to the highest point of the surrounding gingiva. The bar abutment plateau should be approx. 0.5 mm supragingival.

PROSTHETIC SCREWS FOR BAR ABUTMENT, HEX

All bar bases are attached with prosthetic screws for bar abutment, hex, to the CAMLOG® bar abutments. New unused prosthetic screws are used for final insertion.

ART. NO.	J4005.1602	J4005.2002
		
Thread	M 1.6 for bar abutment Ø 3.3/3.8/4.3 mm	M 2.0 for bar abutment Ø 5.0/6.0 mm
Def. torque for insertion of the bar framework:	15 Ncm	

Abutments must be retightened to the same torque after about five minutes to reach the maximum retaining screw tension. This prevents screws from loosening. The prosthetic screws are only hand-tightened on the working cast.

CAMLOG® IMPRESSION TAKING OPTIONS

After successful implant insertion, the impression can be taken in two versions:

IMPRESSION TAKING OVER CAMLOG® BAR ABUTMENTS:

Impression taking after final insertion of the CAMLOG® bar abutments with impression posts for bar abutment. The cast is then fabricated with soldering aid/bar lab analogs.

IMPRESSION TAKING OVER CAMLOG® IMPLANT SHOULDER:

Impression taken over the CAMLOG® implant shoulder directly with CAMLOG® impression posts, open or closed tray, before insertion of CAMLOG® bar abutments. The cast is then fabricated with CAMLOG® lab analogs. See also page 13–15 and working instruction "Impression taking, bite registration and temporary restoration on CAMLOG® implants", Art. No. J8000.0065.

IMPRESSION TAKING OVER CAMLOG® BAR ABUTMENTS

INSERTION OF CAMLOG® BAR ABUTMENTS

After successful implant insertion and determination of the appropriate gingival height, the CAMLOG® bar abutments are inserted into the CAMLOG® implants.

The abutments are inserted into the driver for bar abutments. A driver is available for each implant diameter 3.3/3.8/4.3 mm and 5.0/6.0 mm. A screw integrated in the instrument secures the abutment. The screw is tightened by hand.

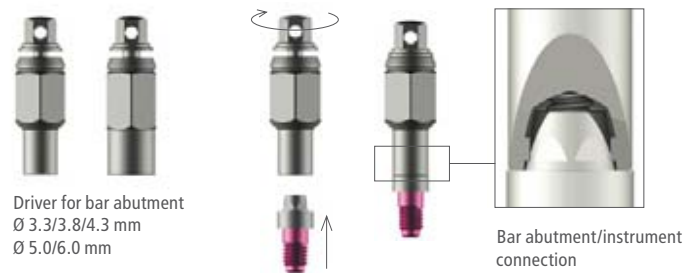

The CAMLOG® bar abutments are inserted into the previously cleaned CAMLOG® implants and the torque wrench is then used to tighten the abutments definitely in the implants based on the specified tightening torque.

TIGHTENING TORQUE FOR CAMLOG® BAR ABUTMENTS

Ø 3.3 mm	20 Ncm
Ø 3.8/4.3/5.0/6.0 mm	30 Ncm

CAMLOG® abutments must be retightened to the same torque after about five minutes to reach the maximum screw tension. This prevents screws from loosening to the extent possible.

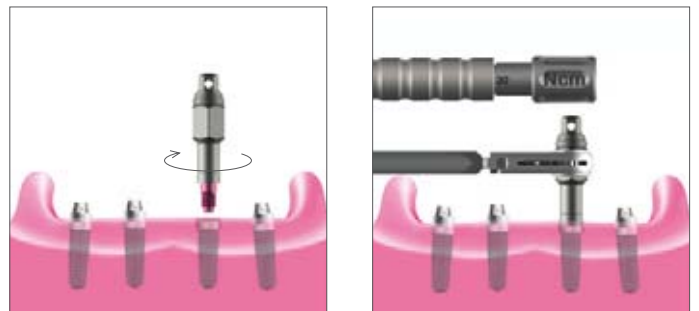

BAR RESTORATIONS

For impression taking, the impression post for the CAMLOG® bar abutment is inserted into the driver for impression posts and healing caps for bar abutments. A driver is available for each implant diameter 3.3/3.8/4.3 mm and 5.0/6.0 mm.

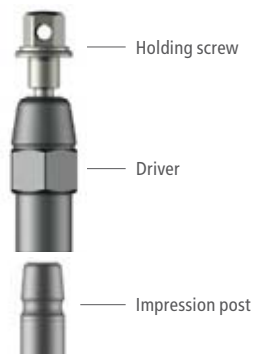

Driver for impression posts and healing caps for CAMLOG® bar abutments



Mounted impression post

The impression post is then screwed onto the CAMLOG® bar abutment fitted in the CAMLOG® implant.

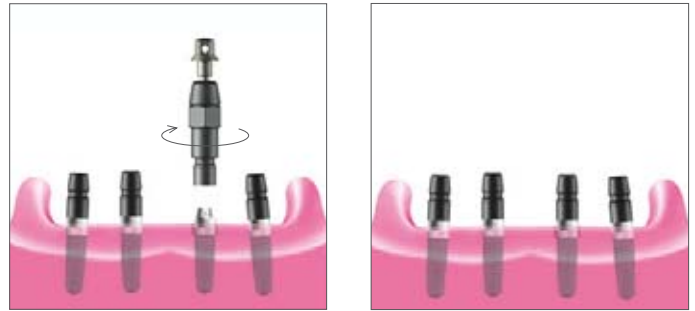

A closed tray is suitable for impression taking. Then use a silicone or poly-ether impression material to take the impression.

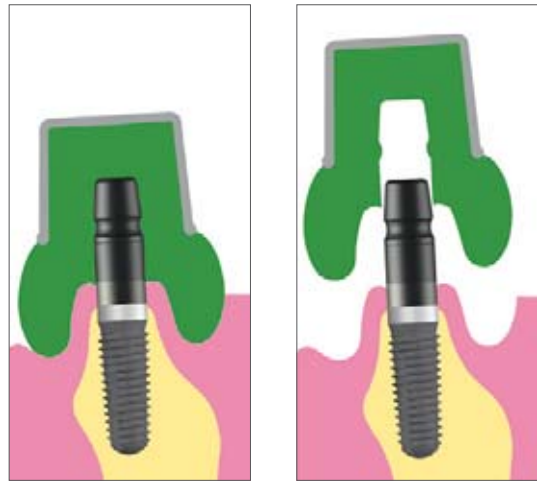

After removing the impression, the impression posts remain on the CAMLOG® bar abutments.

The impression posts are then reattached with the driver for impression posts and healing caps for bar abutments and unscrewed from the bar abutment.

The bar abutments remain in the implants. The impression posts are handed over to the dental laboratory.



The screwdriver (hex) is then used to screw healing caps for bar abutments onto the bar abutments based on the implant diameters used. The healing cap for bar abutment protects the bar abutment and at the same time assumes the function of a gingival former.

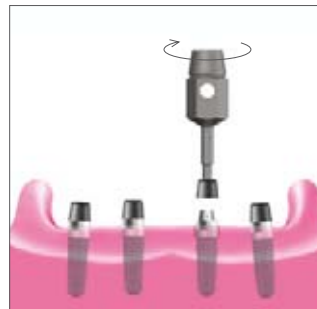

CAST FABRICATION

In the dental laboratory, the impression posts for bar abutments are tightened by hand to the soldering aid/bar lab analogs and repositioned in the impression. A soldering aid/bar lab analog is available for each implant diameter 3.3/3.8/4.3 mm and 5.0/6.0 mm.



Impression post for bar abutment with soldering aid/bar lab analog



BAR RESTORATIONS

The cast is fabricated in the usual manner with suitable material.



After the cast material has cured and the impression removed, the impression posts for bar abutments remain on the soldering aid/bar lab analogs. The impression posts are unscrewed from the soldering aid/bar lab analogs. Based on the planning, the bars are fabricated with the intended bar bases.



Finished working cast with soldering aid/bar lab analogs

IMPRESSION TAKING OVER THE CAMLOG® IMPLANT SHOULDER

INSERTING THE CAMLOG® BAR ABUTMENTS INTO THE WORKING CAST

The dental technician selects the appropriate CAMLOG® bar abutments according to the CAMLOG® implant diameter used (note color-coding) and the specific gingival heights and inserts them into the CAMLOG® lab analogs.

The CAMLOG® bar abutments are inserted into the driver for bar abutments. A driver is available for each implant diameter 3.3/3.8/4.3 mm and 5.0/6.0 mm. A screw integrated in the instrument secures the abutment. The screw is tightened by hand.



The driver is used to tighten the CAMLOG® bar abutments by hand. The bar abutment plateau should be approx. 0.5 mm supragingival.



IMPORTANT NOTE

The bar abutments must not be modified!

The bar is fabricated on the cast. A previously prepared silicone index is used to virtually represent the space available in the planning and fabrication of the bar construction.



Finished working cast with CAMLOG® bar abutments

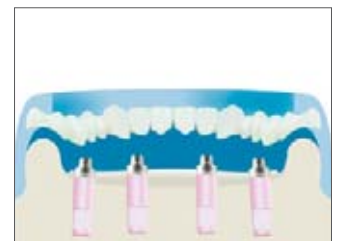

Working cast with silicone index

BAR RESTORATIONS

FABRICATION OF THE BAR CONSTRUCTION CAST BAR CONSTRUCTIONS

Various bar bases are available for bar fabrication using casting technology:

FULL CASTING TECHNIQUE BASE FOR BAR ABUTMENT, BURN-OUT

Fabrication of a cast bar construction with prefabricated bar base made of burn-out plastic (POM) for full casting technique. A prosthetic screw for bar abutment (hex) based on the diameter is used to attach the bar base to the CAMLOG® bar abutment.

CAUTION

To avoid deforming the bar base, only tighten the prosthetic screw lightly by hand.

The bar base can be shortened occlusally to the height of the screwed prosthetic screw. The overall height of the base is 14 mm.

**EXAMPLE:
WORKING CAST WITH CAMLOG® LAB ANALOGS
(TITANIUM ALLOY).**

WAX-UP

The bar wax-up is created based on the planning on the burn-out bar base directly. The wax thickness over the plastic coping should be at least 0.3 mm. Do not cover the delicate edge of the base with wax. Prefabricated bar components made of wax / plastic can also be used to fabricate a pre-milled bar construction.

IMPORTANT NOTE

When burning out the casting muffle, swelling may occur due to the thermal expansion of the plastic and damage the investment compound in the area of the plastic base. This can cause investment compound to be included in the casting metal. Therefore, a minimum wax thickness of 0.3 mm should be applied to the plastic base. When heating, the wax softens first and gives the plastic enough space to expand.



Base for bar abutment, burn-out, with prosthetic screw

Screw-retained base on the CAMLOG® bar abutment

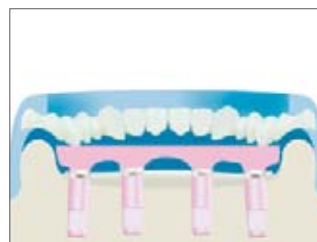

Example: Milled bar construction

INVESTMENT, CAST AND DEVESTMENT

The abutment is embedded according to the instruction manual of the muffle system used. We do not recommend the use of a wax wetting agent. However, if wax wetting agents are used, it must be suitable for use with POM plastic components. When embedding, the correct placement of the wax-up in the casting muffle is of importance. Volume ratios and pin angles must be selected so that the required temperature for casting is achieved. This is particularly important for voluminous casts. We recommend phosphate bound investment materials. The manufacturer's processing instructions must be observed and the mixing ratios and preheating times accurately observed. We recommend you do not use any quick heating processes (speed investment materials). The cast delay time must be kept as brief as possible.

After casting, the cast object must be slowly cooled to room temperature and the object gently devested. We recommend gentle devestment in an ultrasonic bath with waterjet or stripping.

After casting, suitable reworking reamers are available to remove/smooth out casting residues for reworking the screw seat and the shoulder contact area to the CAMLOG® bar abutment.

After trimming the bar, it is checked for a precision fit. Good hygiene capacity must be ensured. A distance of min. 2 mm to the gingiva must be maintained to prevent insufficient cleaning and associated changes to the mucous membrane.

The secondary framework, e.g. electroplating technique, is then fabricated.



Reworking reamer, for base for bar abutment, for the screw seat
Ø 3.3/3.8/4.3 mm and 5.0/6.0 mm

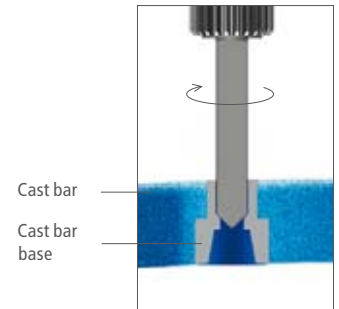

Reaming out the screw channel of the cast bar base



Reworking reamer, for base for bar abutment, for the plane surface/cone seat
Ø 3.3/3.8/4.3 mm and 5.0/6.0 mm

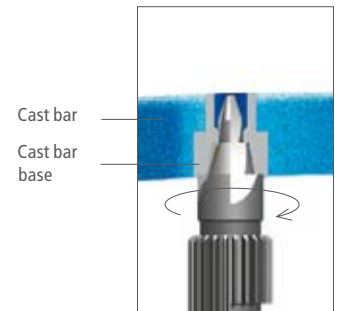

Reaming out the inner cone and plane surface of the cast bar base

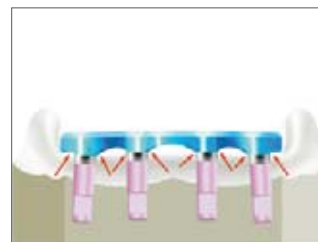

Example: Milled bar construction



Example: Milled bar construction with secondary framework using the electroplating technique and tertiary structure

BAR RESTORATIONS

INSERTING THE BAR CONSTRUCTION

The CAMLOG® bar abutments are transferred from the working cast to the CAMLOG® implants and screwed in definitely with the prescribed torque. The finished bar construction is transferred to the CAMLOG® bar abutments and fixed definitely with 15 Ncm with new unused prosthetic screws, using a screwdriver (hex). The newly created full denture is then inserted and checked for proper fit.

SLEEVE FOR TITANIUM BONDING BASE, BURN- OUT (PASSIVE FIT)

Cast bar version with prefabricated bar sleeve made of burn-out plastic (POM) for full casting technique and titanium bonding base as a retaining element for the implant. The Passive Fit System makes it possible to fabricate cast bars absolutely tension-free. For bar fabrication, the bar sleeve is placed over the titanium bonding base. After completing the bar, it is bonded to the implants with the titanium bonding bases. The plastic sleeve of the bar base can be shortened occlusally to the height of the prosthetic screw. The overall height of the plastic sleeve is 14 mm.



Sleeve for titanium bonding base, burn-out, bondable (passive fit)

EXAMPLE: WORKING CAST WITH CAMLOG® LAB ANALOGS (TITANIUM ALLOY).

WAX-UP

The bar wax-up is created based on the planning on the burn-out bar base directly. The wax thickness over the plastic coping should be at least 0.3 mm. Do not cover the delicate edge of the base with wax. Prefabricated bar components made of wax / plastic can also be used to fabricate a pre-milled bar construction.

Embedding, casting and deinvestment happen as described on page 28–29 "BASE FOR BAR ABUTMENT, BURN-OUT".

TRIMMING

After devestment and cleaning of the cast, the internal fixation edges (screw seat) are removed from the bar sleeves with a round bur (Ø 2.4 mm). The prosthetic screw must slide lightly through the bar sleeve. The final screw seat is on the titanium bonding base.



Cast bar construction



Removing the screw seat



Checking the screw mobility



Fit of the bonding base

After trimming, prosthetic screws are used to attach the titanium bonding bases on the cast. The bar is placed on the titanium bonding bases and the fit checked.

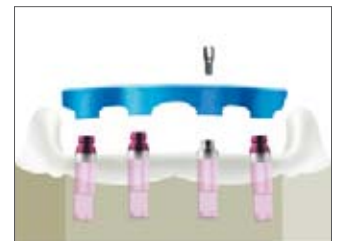

If the bar is seated tension-free on the cast at the try-in, it can then be bonded to the titanium bonding bases.



BONDING THE CAST BAR TO THE TITANIUM BONDING BASES

After completing the bar framework, the CAMLOG® bar abutments are transferred from the cast to the implants and screwed in by hand.

The titanium bonding bases are placed on the CAMLOG® bar abutments and with the prosthetic screw, screwed on by hand.



Insertion of CAMLOG® bar abutments



Placing the titanium bonding bases

BAR RESTORATIONS

The bar framework is then placed on the titanium bonding bases and the fit checked. The bar must be placed on the titanium bonding bases tension-free.



The bonding surfaces of the bar framework and titanium bases are then conditioned based on the manufacturer's specifications. We recommend carefully sandblasting the bonding surfaces before bonding. When bonding, care should be taken that the prosthetic screw does not come into contact with the bonding material. We recommend covering the internal hex of the screw head with wax. After the bonding material has cured, the prosthetic screws are loosened, the bar removed from the CAMLOG® bar abutments, the excess bonding material carefully removed and the bar abutments removed. The new full denture is then fabricated on the working cast.

INSERTING THE BAR CONSTRUCTION

The CAMLOG® bar abutments are transferred from the working cast to the CAMLOG® implants and screwed in at the prescribed torques. The finished bar construction is transferred to the CAMLOG® bar abutments and fixed definitely with new unused prosthetic screws, using a screwdriver (hex) with 15 Ncm. The newly created full denture is then inserted and checked for proper fit.

CAST-ON TECHNIQUE BASE FOR BAR ABUTMENT, CAST-ON

Cast bar version with prefabricated bar base made of high-melting cast-on alloy and burn-out plastic sleeve (POM) for cast-on technique. A prosthetic screw for bar abutment (hex) based on the diameter is used to fix the bar base on the CAMLOG® bar abutment. The plastic sleeve of the bar base can be shortened occlusally to the height of the prosthetic screw. The overall height of the base is 13 mm.

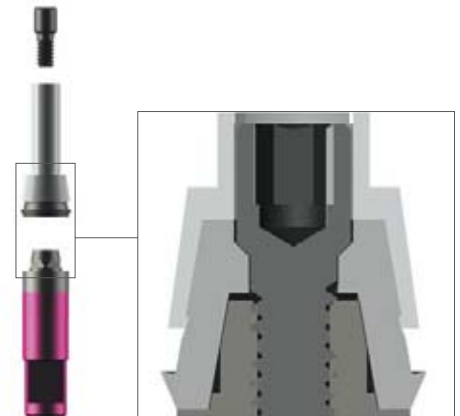

Base for bar abutment, cast-on



Setting up the bar bases

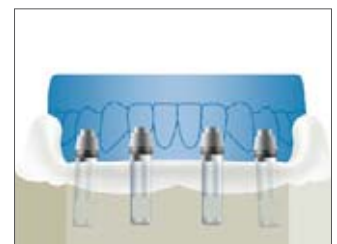

Shortened bar bases

WAX-UP

The bar wax-up is created based on the planning on the burn-out plastic sleeve and bar base directly. The wax thickness over the plastic sleeve should be at least 0.3 mm. The bar base consists of a non-oxidizing alloy. Do not cover the fine gold margin of the base with wax. Prefabricated bar components made of wax / plastic can also be used to fabricate a pre-milled bar construction.

CAUTION

Do not cover the fine gold margin of the bar base with wax. This can lead to a surplus of cast-on alloy on or over the margin on the implant shoulder support.

After wax-up of the bar framework, a suitable agent must be used to clean the fine gold margin and the area of the implant shoulder support of separating medium and wax particles (e.g. with a cotton swab soaked in alcohol).

EMBEDDING AND CASTING

The abutment is embedded according to the instruction manual of the muffle system used. We do not recommend the use of a wax wetting agents. The fine film from the agent can lead to a surplus of cast-on alloy on the margin or on the implant shoulder support. When embedding, the correct placement of the wax-up in the casting muffle is of importance. Volume ratios and pin angles must be selected so that the required temperature for formation of a metallic connection is achieved. This is particularly important for voluminous casts.

The investment compound must be matched with the cast-on alloy and the casting alloy used. We recommend phosphate bound investment materials. The manufacturer's processing instructions must be observed and the mixing ratios and preheating times accurately observed. We recommend you do not use any investment materials for the quick heating processes (speed investment materials). The cast delay time must be kept as brief as possible.

INSTRUCTIONS FOR THE CAST-ON ALLOYS

The casting alloy may not exceed the liquidus temperature of 1350°C (2462°F) in its melting range. The melting range of the high-melting cast-on gold alloy lies between 1400°C– 1490°C (2552°F–2714°F).

The casting alloy must contain gold in its components and be compatible with the high-melting cast-on gold alloy. Observe the instructions of the alloy manufacturer.

The use of other cast-on alloys is not recommended because gold alloys with nickel or cobalt components can destroy the base part. Components of an unsuitable alloy can lead to phases with reduced corrosion resistance, less stability or a low melting range thanks to "diffusion processes" in the border zone "casting alloy/cast-on alloy".

DEVESTMENT

After casting, the cast object must be slowly cooled to room temperature and the object gently devested.

IMPORTANT NOTE

Never use sandblasting to devest the cast; this would destroy the precise fit on the CAMLOG® bar abutment shoulder (precision fit reduced, poor margin fit)!

We recommend gentle devestment in an ultrasonic bath with waterjet or stripping.

CASTING QUALITY

If the cast object exhibits casting defects after devestment such as incomplete distribution or casting fins/bubbles over the margin onto the implant shoulder support, the work should be repeated. The precision of the prefabricated bar base is severely affected and also the long-term success of the prosthetic restoration. The bar framework must be seated tension-free on the CAMLOG® bar abutments.

The secondary framework, e.g. electroplating technique, is then fabricated.

INSERTING THE BAR CONSTRUCTION

The CAMLOG® bar abutments are transferred from the working cast to the CAMLOG® implants and screwed in with the prescribed torques. The finished bar construction is transferred to the CAMLOG® bar abutments and fixed with new unused prosthetic screws, using a screwdriver (hex) with 15 Ncm. The newly created full denture is then inserted and checked for proper fit.

BAR RESTORATIONS

LASER-WELDED BAR CONSTRUCTION

BASE FOR BAR ABUTMENT, LASER-WELDABLE

Laser-welded bar construction with prefabricated bar bases made of pure titanium (titanium Grade 4). A prosthetic screw for bar abutment (hex) based on the diameter is used to fix the bar base on the CAMLOG® bar abutment. The height of the bar base is 5.3 mm.



Base for bar abutment, laser-weldable



Setting up the bar bases



Bar bases with fitted prefabricated bar components made of pure titanium

EXAMPLE:

WORKING CAST WITH SOLDERING AIDS/BAR LAB ANALOGS FOR BAR ABUTMENTS (STAINLESS STEEL).

The bar elements are cut accordingly and in consideration of a joining gap that is as small as possible fitted between the bar bases.

After assembling all the components, the bar segments are welded together with the bar copings under sufficient argon gas purging and the bar is high-gloss polished. The bar must be seated tension-free on the CAMLOG® bar abutments.

IMPORTANT NOTE ABOUT LASER WELDING

Blue discoloration on the welds must be avoided. These points to insufficient purging with argon gas and to oxygen uptake of the titanium. Brittleness and associated weakness in the weld is the result. Observe the operating instructions of the laser devices used!

After completing the bar construction, the final bar prosthesis with base reinforcement out of metal is fabricated in the usual manner. The teeth are positioned based on the principle of modern complete dentures. An existing full denture can also be converted into a bar-retained prosthesis with suitable bar matrices.



IMPORTANT NOTE

The matrix should be placed before fabrication of the prosthesis with a suitable relief wire. Only then is vertical translation of the prosthesis on the bar ensured.

INSERTING THE BAR CONSTRUCTION

The CAMLOG® bar abutments are transferred from the working cast to the CAMLOG® implants and screwed in with the prescribed torques. The finished bar construction is transferred to the CAMLOG® bar abutments and fixed with new unused prosthetic screws, using a screwdriver (hex) with 15 Ncm. The newly created full denture is then inserted and checked for proper fit.



**SOLDERED BAR CONSTRUCTION
BASE FOR BAR ABUTMENT, SOLDERABLE**

Soldered bar construction with prefabricated bar bases made of solderable gold alloy. A prosthetic screw for bar abutment (hex) is used to fix the bar base on the CAMLOG® bar abutment. The height of the bar base is 5.3 mm.



Base for bar abutment, solderable



Setting up the solderable bar bases



Bar bases with fitted prefabricated bar components made of solderable gold alloy

**EXAMPLE:
WORKING CAST WITH SOLDERING AIDS/BAR LAB ANALOGS
FOR BAR ABUTMENT (STAINLESS STEEL).**

The bar elements are cut accordingly and in consideration of a joining gap that is as small as possible fitted between the bar bases. The bar components are mounted to residue-free burn-out plastic, the prosthetic screws loosen after curing and the bar lifted off the cast. Soldering aids/lab analogs (stainless steel) are inserted in the bar bases and hand tightened with screws, hex, for bar abutments (thread M1.6 for Ø 3.3/3.8/4.3 mm; thread M2.0 for Ø 5.0/ 6.0mm; stainless steel).

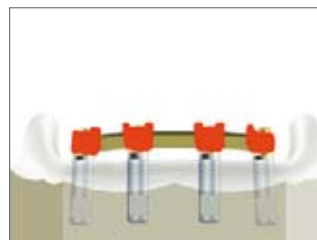

Fixed bar components



Soldering aids/lab analogs with bar and screws, hex, for bar abutment

With the bar prepared for soldering, a soldering model is fabricated in the conventional manner.

NOTE
The instruction manuals of the soldering material manufactures must be observed!

BAR RESTORATIONS

The soldering is carried out according to the instructions of the soldering material and solder manufacturers. To avoid deformation of the soldering model, we recommend preheating the soldering model in the preheating furnace at approx. 500-600°C (932–1112°F). The plastic burns uniformly by doing so. After preheating the model in the furnace, the embedded bar can be soldered. Then allow the soldering mode to cool to room temperature. The bar is deusted in an ultrasonic bath and then cleaned of oxides and flux residues in an acid bath.

IMPORTANT NOTE

Never use sandblasting to deust the bar; this would destroy the precise fit of the bar base on the CAMLOG® bar abutment shoulder!

TIP: To protect the edges when trimming/polishing, the bar bases can be attached to soldering aids/bar lab analogs.

The finished bar must be seated tension-free on the CAMLOG® bar abutments.

After completing the bar construction, the final bar prosthesis with base reinforcement out of metal is fabricated in the usual manner. The teeth are positioned based on the principle of modern complete dentures. An existing full denture can also be converted into a bar-retained prosthesis with suitable bar matrices.

IMPORTANT NOTE

The matrix should be placed before fabrication of the prosthesis with a suitable relief wire. Only then is vertical translation of the prosthesis on the bar ensured.

INSERTING THE BAR CONSTRUCTION

The CAMLOG® bar abutments are transferred from the working cast to the CAMLOG® implants and screwed in with the prescribed torques. The finished bar construction is transferred to the CAMLOG® bar abutments and fixed with new unused prosthetic screws, using a screwdriver (hex) with 15 Ncm. The newly created full denture is then inserted and checked for proper fit.

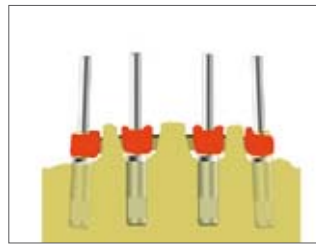

Fabricating the soldering model

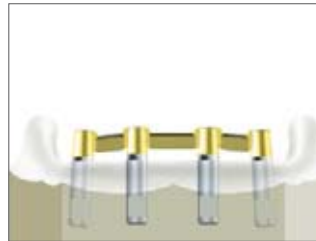

Finished bar

RELINING OF A BAR-SUPPORTED FULL DENTURE

If relining is necessary to retain the function of a bar-supported full denture, the holding pins for bars can be used.

The holding pins for bars are used exclusively to attach a bar during the relining impression taking for an indirect relining. The holding pins for bars hold the bar in the relining impression. It is not necessary to block out the bar in the mouth; it is easily carried out on the relining model.

The holding pins for bars are available in two sizes:

HOLDING PIN FOR BAR, YELLOW, FOR THREAD M1.6

Can be used for CAMLOG® bar abutment Ø 3.3/3.8/4.3 mm and soldering aid/bar lab analog Ø 3.3/3.8/4.3 mm



HOLDING PIN FOR BAR, BLUE, FOR THREAD M2.0

Can be used for CAMLOG® bar abutment Ø 5.0/6.0 mm and soldering aid/bar lab analog Ø 5.0/6.0 mm



The holding pins for bars are for single use only and must be disinfected before use (no sterilization). See also the "Preparation Instructions for the CAMLOG®/CONELOG® Implant System", Art. No. J8000.0032.

PROCESSING

PREPARATION OF THE RELINING IMPRESSION TAKING

The bar-supported prosthesis is removed from the mouth. A screwdriver (hex) is used to loosen and remove the prosthetic screws from the CAMLOG® bar abutments.

Take measures to protect against aspiration!

INSERTING THE HOLDING PINS FOR BARS

The holding pins for bars are selected based on the diameter of the CAMLOG® bar abutments. A screwdriver (hex) is used to grab the holding pins for bars and to push them into the screw openings. Limited friction between the screwdriver and the holding pin for bars prevents loosening during application. The screwdriver can then be easily removed. The bar is then fixed with the holding pins for bars in the patient's mouth. It is important to check (e.g. occlusally pressing with a finger) the proper fit of all applied holding pins for bars just before taking the impression. Blocking out the bar is unnecessary.

IMPRESSION TAKING

The relining impression for bar-supported prosthesis can be taken as usual. Make sure that the impression material fills in under the bar component completely.

The prosthesis impression can be removed after the prescribed setting time of the impression material. The bar incl. the holding pins for bars remains in the prosthesis impression surrounded by impression material.

BAR RESTORATIONS

PREPARING AND FABRICATING THE RELINING MODEL

The soldering aid/bar lab analog that fits is selected based on the diameter used. It is inserted into the bar base and holds with the friction of the holding pin for bars. Ensure the proper fit of the soldering aid/bar lab analog in the bar base. Also use sticky wax or similar to hold the soldering aid/bar lab analog if necessary.

The relining model is then fabricated in the usual way.

RELINING

After fabricating the relining model, the bar is placed on the model and attached with prosthetic screws for bar abutments.

The areas underneath are blocked out. The relining is then finished in the usual way based on the procedure for relining a bar-supported prosthesis.

REPLACING THE BAR AND PROSTHESIS

The bar is fixed in the patient's mouth using unused prosthetic screws for bar abutments. The bar is inserted and the prosthetic screws are tightened to the specified torque of 15 Ncm. The prosthesis is then inserted and checked for proper seating and occlusion.



Holding pin for bar, bar base, soldering aid/bar lab analog

BALL ABUTMENT ANCHORING SYSTEM

INTRODUCTION

In implantological hybrid prosthetics, ball abutment restorations represent movable anchorings that allow rotational movements of the prosthesis in one or more directions respectively vertical translation movements. Ball abutments should generally be perpendicular to the occlusal plane to make axial loading of the implant possible.

TASKS OF A BALL ANCHORING RESTORATION

- Protecting the prosthesis against shearing and lifting forces
- Shear distribution
- Possible axial transfer of mastication forces between the prosthesis and implant
- Resilience compensation through degrees of freedom

INDICATIONS:

- Resilient anchoring of implant-supported full dentures for the edentulous maxilla and mandible in combination with 2 CAMLOG® implants to secure a tangential rotation axis.
- Anchoring of implant-supported full dentures for the edentulous maxilla and mandible in combination with 4 CAMLOG® implants.

CONTRAINDICATIONS:

- Uneven number of implants per arch
- Improperly placed implants that prevent a tangential rotation axis
- Combination with other retention devices
- Use with disparallel-placed implants with an angulation of more than 10° to the implant axis

PRODUCT DESCRIPTION

CAMLOG® ball abutments are color-coded and available for CAMLOG® implants in the 3.3/3.8/4.3/5.0 mm diameters in various gingival heights. CAMLOG® ball abutment sets are also available consisting of a CAMLOG® ball abutment, red duplication aid/spacer, stabilizing ring and ball abutment analog. The ball diameter is 2.25 mm.

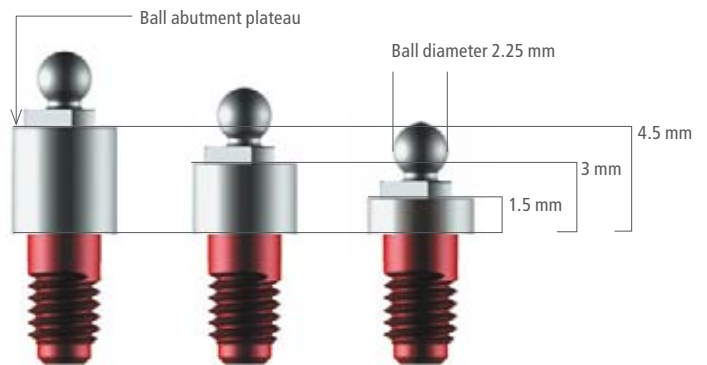

Gingival heights of CAMLOG® ball abutments



Driver for CAMLOG® ball abutments

The driver for CAMLOG® ball abutments, manual/wrench, is used to screw the CAMLOG® ball abutments into its final position in the CAMLOG® implants. The torque for CAMLOG® ball abutment Ø 3.3 mm is 20 Ncm and for Ø 3.8/4.3/5.0 mm 30 Ncm.

After insertion, the ball abutment plateau should be at least 1.0 mm supra-gingival.

BALL ABUTMENT ANCHORING SYSTEM

CAMLOG® BALL ABUTMENT SET FOR IMPLANT DIAMETER 3.3 MM

Art. No.	J2250.3315	J2250.3330
		
GH	1.5 mm	3.0 mm

CAMLOG® BALL ABUTMENT SET FOR IMPLANT DIAMETER 3.8 MM

Art. No. .	J2250.3815	J2250.3830	J2250.3845
			
GH	1.5 mm	3.0 mm	4.5 mm

CAMLOG® BALL ABUTMENT SET FOR IMPLANT DIAMETER 4.3 MM

Art. No.	J2250.4315	J2250.4330	J2250.4345
			
GH	1.5 mm	3.0 mm	4.5 mm

CAMLOG® BALL ABUTMENT SET FOR IMPLANT DIAMETER 5.0 MM

Art. No.	J2250.5015	J2250.5030	J2250.5045
			
GH	1.5 mm	3.0 mm	4.5 mm

GH: Gingival height

CAMLOG® BALL ABUTMENT FOR IMPLANT DIAMETER 3.3 MM

Art. No.	J2249.3315	J2249.3330
		
GH	1.5 mm	3.0 mm

CAMLOG® BALL ABUTMENT FOR IMPLANT DIAMETER 3.8 MM

Art. No.	J2249.3815	J2249.3830	J2249.3845
			
GH	1.5 mm	3.0 mm	4.5 mm

CAMLOG® BALL ABUTMENT FOR IMPLANT DIAMETER 4.3 MM

Art. No.	J2249.4315	J2249.4330	J2249.4345
			
GH	1.5 mm	3.0 mm	4.5 mm

CAMLOG® BALL ABUTMENT FOR IMPLANT DIAMETER 5.0 MM

Art. No.	J2249.5015	J2249.5030	J2249.5045
			
GH	1.5 mm	3.0 mm	4.5 mm

GH: Gingival height

The retention force of the matrix CM Dalbo® Plus belonging to the CAMLOG® ball abutment is adjustable stepless from "weak" to "strong" through the lamella retention insert. This makes the CAMLOG® ball abutment eminently suitable for implant-retained full dentures. If necessary, the screwdriver/activator for ball abutment matrix CM Dalbo® Plus can be used to unscrew the lamella retention insert for replacement.



CAMLOG® ball abutment with mounted matrix CM Dalbo® Plus



Screwdriver/activator for ball abutment matrix CM Dalbo® Plus



Lamella retention insert of the matrix CM Dalbo® Plus

BALL ABUTMENT ANCHORING SYSTEM

SETTING THE RETENTION FORCE

With the lamella retention insert at maximum, the retention force is approximately 1200 g. The force is approximately 200 g on delivery. The force can be regulated by screwing the activator in and out.

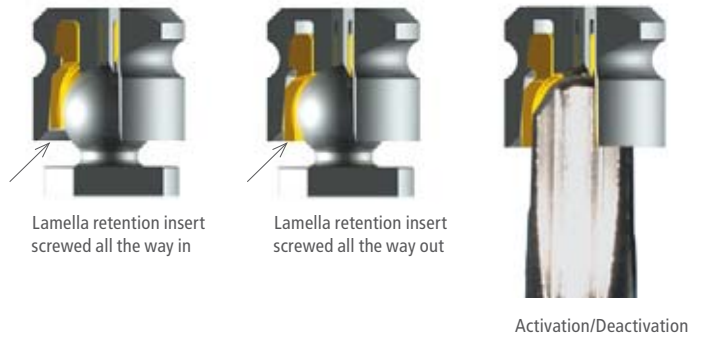

The special thread of the slotted lamella retention insert is slightly tapered when turning in to prevent accidental misadjustment.

IMPORTANT NOTE

The lamella retention insert must never extend out of the housing (see arrows), otherwise it may come loose and the matrix will be lifted.

CAMLOG® IMPRESSION TAKING OPTIONS

After successful implant insertion, the impression can be taken in two versions:

Impression taking over CAMLOG® implant shoulder for fabrication of a new ball-retained full denture:

Impression taken over the CAMLOG® implant shoulder directly with CAMLOG® impression post, open or closed tray, before insertion of CAMLOG® ball abutments for fabrication of a new prosthesis. The cast is then fabricated with CAMLOG® lab analogs. See also CAMLOG® cast fabrication on page 13–15. Further information is available in the working instruction "Impression Taking, Bite Registration and Temporary Restoration on CAMLOG® Implants", Art. No. J8000.0065.

We recommend impression taking open tray because it can be combined with a functional impression to fabricate an extension prosthesis.

Impression taking over CAMLOG® ball abutments for broadening of an existing full denture into a ball abutment-retained prosthesis and/or for relining impression taking of an existing ball abutment-retained full denture:

Direct impression taking over the CAMLOG® ball abutments. The cast is then fabricated with the ball abutment analog. The ball abutment analog is available for implant diameters 3.3/3.8/4.3/5.0 mm incl. stabilizing ring.

BALL ABUTMENT ANALOG, incl. stabilizing ring

Art. No.	J3015.3300	J3015.3800	J3015.4300	J3015.5000
Implant Ø	3.3 mm	3.8 mm	4.3 mm	5.0 mm

FABRICATION OF A NEW BALL ABUTMENT-RETAINED FULL DENTURE WITH INTEGRATED METAL REINFORCEMENT

SELECTION AND INSERTION OF THE CAMLOG® BALL ABUTMENT

After fabricating the cast with CAMLOG® lab analogs, the CAMLOG® ball abutments are inserted. In conformance with the specified implant diameters and gingival heights, the dental technician selects the CAMLOG® ball abutments on the master cast and uses the driver for ball abutments to manually screw them into the CAMLOG® lab analog.

Different abutment heights can be selected to compensate for differences in levels in the gingival margin and implants. The ball heads should be at a uniform level for the best possible retention effect. The ball abutment plateau should be approx. 1 mm supragingival.

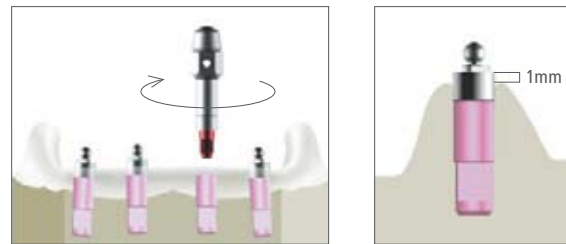

ALIGNING THE DUPLICATION AIDS/SPACER

The included stabilizing rings (white) are placed over the CAMLOG® ball abutments and the red duplication aids/spacer are clipped on. Thereby the duplication aids/spacer are aligned parallel to the implant axis. If the implant axes diverge, the stabilizing rings are **NOT** used. The implant axial divergence must not exceed 10° per implant. For a uniform "engaging" of the matrices and uniform activating of the lamella retention inserts, the removal and insertion direction of the denture is important. The duplication aids/spacer are placed parallel on the CAMLOG® ball abutments in the common insertion direction and stabilized with wax. Alternatively, the matrix may be used instead of the duplication aid.

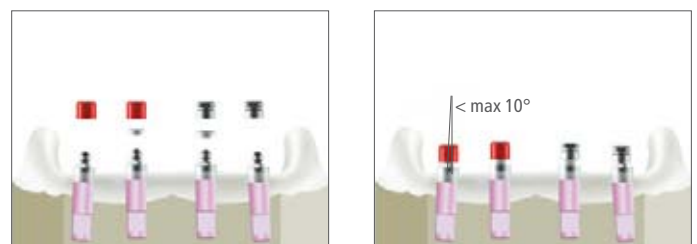

Possible fabrication of the duplication cast with duplication aids or matrices CM Dalbo® Plus

BALL ABUTMENT ANCHORING SYSTEM

DUPLICATING THE WORKING CAST

After the alignment (paralleling) of the duplication aids, undercut sections are blocked out with wax. When using the matrix, it must be covered with a thin coat of wax (0.3 mm) before duplication (bonding space).



Finished duplication cast

FABRICATING THE METAL REINFORCEMENT

A metal reinforcement is waxed similarly to a telescopic frame work. The wax-up is checked using the silicone index. A perforation is provided for excess cement. Soft tissue contacts are integrated in the free-end area and between the implants.



Wax-up of the metal reinforcement



After casting and trimming of the metal reinforcement, the fit is checked on the master cast. The matrices are placed on the CAMLOG® ball abutments. The metal reinforcement must be seated tension-free on the matrices and the parallelism may not be changed.

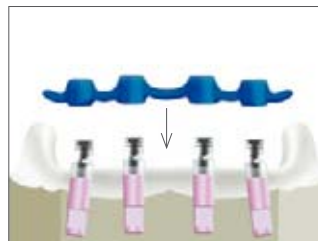

BONDING THE MATRICES IN THE METAL REINFORCEMENT

The bonding surfaces are conditioned. The manufacturer’s bonding directions must be observed. The matrices can be bonded to the framework. The lamella retention insert must be deactivated and insulated before bonding. When deactivated, the lamella retention insert must not extend above the margin of the matrix, otherwise the matrix will lift up from the CAMLOG® ball abutment. The matrices are clipped to the CAMLOG® ball abutments and aligned parallel, accordingly the position set during fabrication of the duplicate cast.

Bonding is performed with a metal attachment bond material accordingly the instruction by the manufacturer.

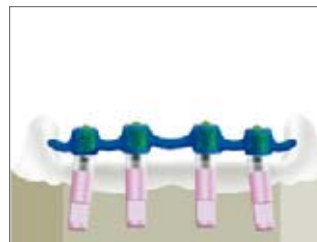
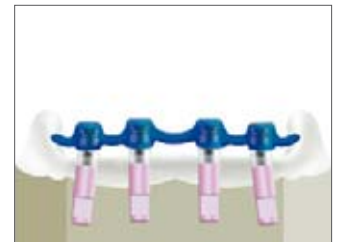

Bonding the matrices in the metal reinforcement

SET-UP AND TRY-IN

The teeth are set up with the silicone index on the metal reinforcement. The denture is completely waxed and prepared for try-in. The try-in is conducted with deactivated matrices. The vertical height, occlusion, articulation, tension-free seating and esthetics are checked during this process.

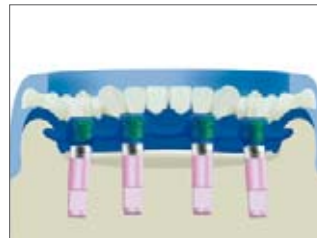

FINISHING

After the try-in, finishing is continued with heat- or cold-cured polymerization in the usual manner. The framework can be coated with pink opaquer beforehand. The matrix housing must be sealed to prevent entry of acrylic (wax, silicone, etc.). The ball abutment-retained full denture must be easy to clean and must function correctly to ensure long-term success.

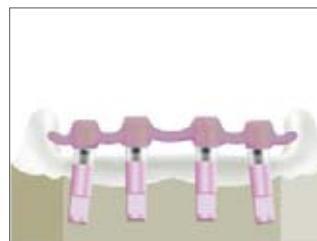

Finished ball abutment-supported full denture

BALL ABUTMENT ANCHORING SYSTEM

INSERTION OF THE CAMLOG® BALL ABUTMENT AND THE PROSTHESIS

After removing the CAMLOG® healing cap, the CAMLOG® ball abutments are transferred from the working cast to the previously cleaned CAMLOG® implant and the driver for ball abutment and the torque wrench are used to tighten the abutments in the implants based on the specified tightening torque.

TIGHTENING TORQUE FOR CAMLOG® BALL ABUTMENTS

Ø 3.3 mm	20 Ncm
Ø 3.8/4.3/5.0 mm	30 Ncm

CAMLOG® abutments must be retightened with the same torque after about five minutes to reach the maximum screw tension. This prevents screws from loosening to the extent possible.

The screwdriver/activator for ball abutment matrix is used to set the required retention force of the lamella retention inserts and the prosthesis is inserted in the patient's mouth.

IMPORTANT NOTE

Do not place the stabilizing ring in the mouth.

The clinical insertion is completed with a check of the occlusion and articulation.



BROADENING OF AN EXISTING FULL DENTURE INTO A BALL ABUTMENT-RETAINED FULL DENTURE

An existing mucosa-supported full denture can be converted into a ball abutment-retained prosthesis in principle, but this will weaken the prosthesis. Because it is known that the chewing force increases with implant-retained dentures, the denture can fracture without metal reinforcement. This procedure can only be considered as a temporary solution.



SELECTION AND INSERTION OF THE CAMLOG® BALL ABUTMENTS

After the CAMLOG® implants have healed, the CAMLOG® ball abutments are inserted. In conformance with the specified implant diameters and gingival heights, the clinician selects the CAMLOG® ball abutments intraorally and uses the driver for ball abutment to screw them into the previously cleaned CAMLOG® implants. Information about torques, see page 46.



Different abutment heights can be selected to compensate for differences in levels in the gingival margin and implants. The ball heads should be at a uniform level for the best possible retention effect. The ball abutment plateau should be approx. 1 mm supragingival.

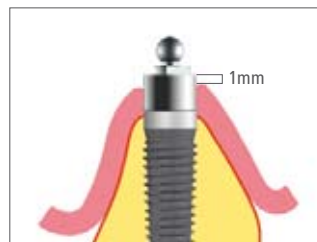

IMPRESSION TAKING OF THE CAMLOG® BALL ABUTMENTS

The impression is taken over the CAMLOG® ball abutments directly without accessories. The CAMLOG® ball abutments must be fully overmolded and integrated with impression material. Silicone or polyether are suitable impression materials.



BALL ABUTMENT ANCHORING SYSTEM

After the impression is taken successfully, the clinician must communicate the implant diameters used for cast fabrication to the dental laboratory. Brass ball abutment analogs of the appropriate diameter are then inserted in the impression without stabilizing rings. The guide areas of the circular plateau ensure that the implant axis is transferred precisely to the master cast. The cast is fabricated in the usual manner with suitable material.

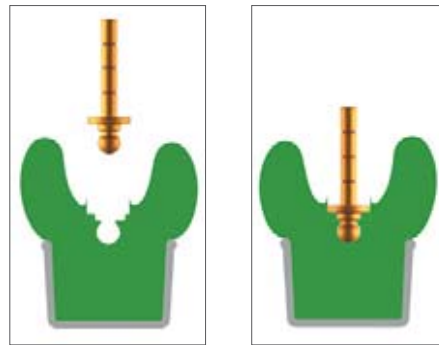

Integrating the ball abutment analogs in the impression

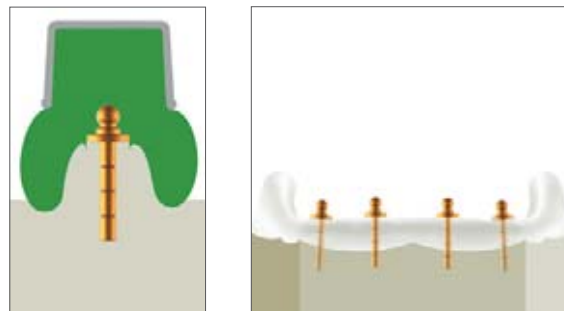

Cast Fabrication

INTEGRATING THE MATRICES

Before placing the matrices, the lamella retention inserts are insulated with vaseline. The matrices are positioned and aligned by the same procedure when fabricating a new ball abutment-retained full denture. The areas underneath are blocked out with plaster. No acrylic should get into the inner configuration of the matrices!

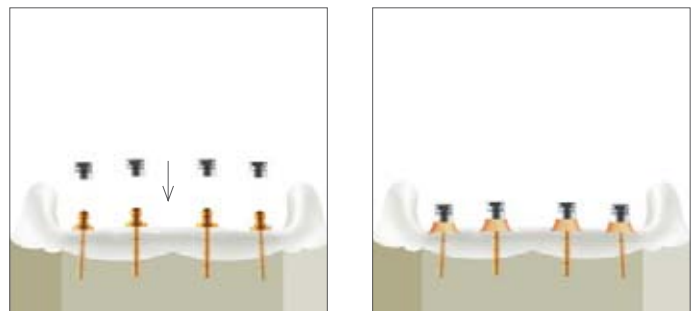

The existing prosthesis base is hollow ground and perforated in the area of the matrices specifically. The perforation is used for visual control and to allow acrylic to escape. The matrix housings can be stained with pink opaquer as required after conditioning the surface.



NOTE

After hollow grinding during the subsequent try-in on the cast, the prosthesis must not come into contact with the matrices and block outs!

A cold-cured polymer is used to attach the matrix housings similar to a direct relining. The matrices must be completely wrapped with acrylic. After curing, the prosthesis is lifted with the polymerized matrices, trimmed and the inner configuration of the matrices cleaned.



The clinician then activates the lamella retention inserts with the screwdriver/activator for ball abutment matrix (see "Setting the retention force" on page 42), the occlusion checked and the finished prosthesis inserted in its final position.



BALL ABUTMENT ANCHORING SYSTEM

RELINING OF A BALL ABUTMENT-RETAINED FULL DENTURE

The denture-bearing area must be checked at regular intervals and if necessary adjusted by relining to ensure that the ball-retained, soft tissue-supported denture retains its long-term function.

IMPRESSION TAKING

The denture base is prepared in accordance with the procedures for a relining impression. For easy removal of the relining impression, the lamella retention inserts must be deactivated in the matrices with the screwdriver/activator for ball abutment matrix before taking the impression. The lamella retention insert must not extend out of the matrix housing (see "Setting the retention force" on page 42).

The relining impression is taken over the CAMLOG® ball abutments directly without accessories. The CAMLOG® ball abutments must be fully overmolded and integrated with impression material. Silicone or polyether are suitable impression materials.

CAST FABRICATION

After the impression is taken successfully, the clinician must communicate the implant diameters used for cast fabrication to the dental laboratory. Brass ball abutment analogs of the appropriate diameter are then inserted in the matrices in the impression without stabilizing rings. The guide areas of the circular plateau ensure that the implant axis is transferred precisely to the master cast. The cast is fabricated in the usual manner with suitable material.

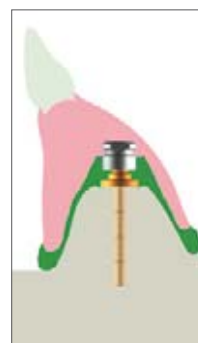
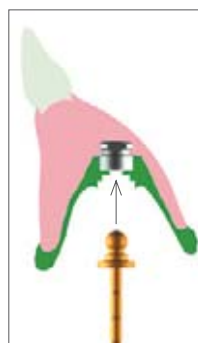
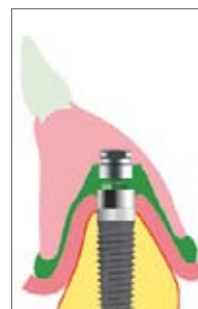

RELINING

NOTE

Before relining, the inner configuration of the matrices must be insulated with Vaseline to prevent acrylic from getting into the matrices. This would destroy the matrices.

The prosthesis is relined in the usual dental manner. After relining, the prosthesis is trimmed and the inner configuration of the matrices cleaned.



The clinician then activates the lamella retention inserts with the screwdriver/activator for ball abutment matrix (see "Setting the retention force" on page 42), the occlusion checked and the finished prosthesis inserted in its final position.



FOLLOW-UP/RECALL

Ball abutment-retained prostheses should be checked for functional reliability initially at intervals of about three months. In doing so, harmful prosthetic movements can be detected early and eliminated by appropriate measures (replacement/activation/deactivation of matrices, relining, occlusion check). The prosthesis is cleaned and the patient instructed again under conditions of poor hygiene.

NOTE

Only clean the components of the ball abutments with suitable instruments. Metal instruments can damage them.

REPLACING THE LAMELLA RETENTION INSERT

The retention force of the lamella retention insert may be reduced by stress or wear. To replace it, use the screwdriver/activator for ball abutment matrix to unscrew it counter-clockwise from the matrix housing (see "Setting the retention force" on page 42). The new lamella retention insert is screwed in clockwise into the matrix housing. Make sure that it is placed axially. For a controlled adjustment of the retention force, the lamella retention insert is first screwed in completely and then unscrewed one complete turn. This sets the retention force to about 200 g (basic setting). The total retention force can be individually adjusted at the time of insertion of the denture.

LOCATOR® ANCHORING SYSTEM

PRODUCT DESCRIPTION

The Locator® anchoring system is intended for use in the tissue-borne and implant-retained prosthesis for resilient supported full dentures in the maxilla and mandible. The system can be used with implant divergences of up to 20° per implant (3.3 mm diameter CAMLOG® Locator® abutment – up to 10° divergence per implant). The self-aligning design of the Locator® anchoring system supports the patient when inserting and seating the prosthesis. The design of the CAMLOG® Locator® abutment and replacement males provide double (dual) retention.

The Locator® anchoring system contains various replacement males with different retention forces. The CAMLOG® Locator® abutments are available for implant diameters 3.3 mm in three gingival heights (1.0, 2.0 and 3.0 mm), and for implant diameters 3.8, 4.3 and 5.0 mm in four gingival heights (1.0, 2.0, 3.0 and 4.0 mm).

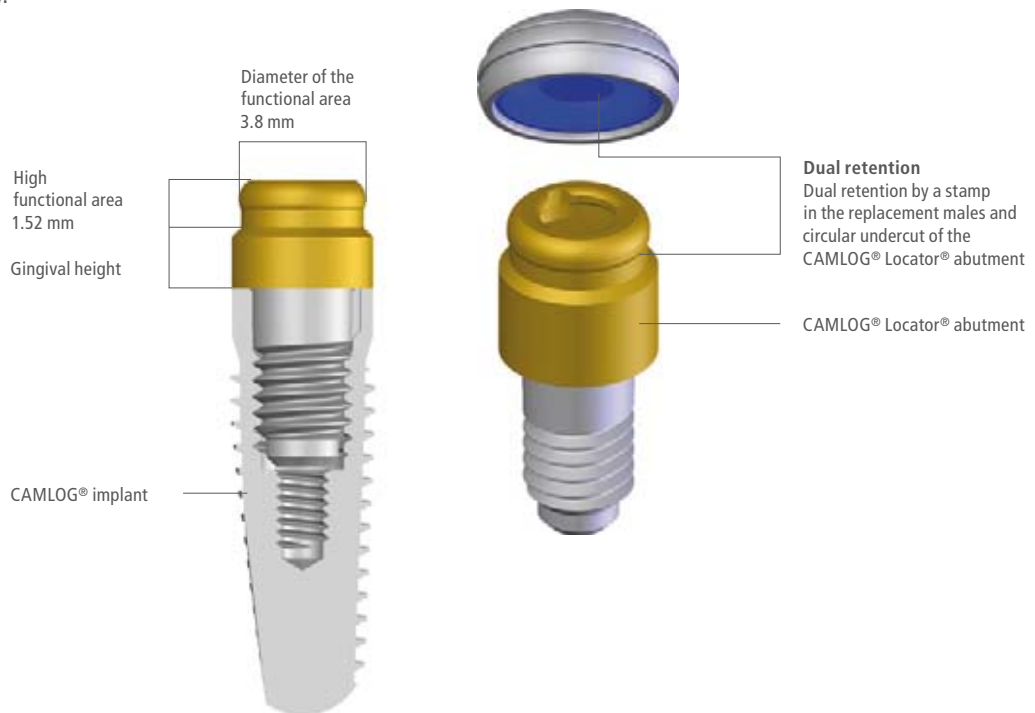

The Locator® anchoring system can also be integrated in a full denture supported on CAMLOG® implants:





- For the fabrication of a new full denture with Locator® retention components
- Converting an existing full denture into a Locator®-retained denture

LOCATOR® SYSTEM COMPONENTS

Art. No.		Article	Implant Ø in mm	GH in mm
J2253.3310		CAMLOG® Locator® abutment	3.3	1.0
J2253.3320				2.0
J2253.3330				3.0
J2253.3810		CAMLOG® Locator® abutment	3.8	1.0
J2253.3820				2.0
J2253.3830				3.0
J2253.3840				4.0
J2253.4310		CAMLOG® Locator® abutment	4.3	1.0
J2253.4320				2.0
J2253.4330				3.0
J2253.4340				4.0
J2253.5010		CAMLOG® Locator® abutment	5.0	1.0
J2253.5020				2.0
J2253.5030				3.0
J2253.5040				4.0
J2253.0200		Locator® impression cap	3.3/3.8/4.3/5.0	
J2253.0340		Locator® analog	3.3/3.8/4.3	
J2253.0350		Locator® analog	5.0	
J2253.0102		Locator® male processing packages (2 units) Content per package: 1 Titanium housing with processing replacement male, 1 Block out spacer white, 1 Replacement male clear, 1 Replacement male pink, 1 Replacement male blue	3.3/3.8/4.3/5.0	
J2253.0112		Locator® male processing packages for extended range (2 units), Content per package: 1 Titanium housing with processing replacement male, 1 Block out spacer white, 1 Replacement male green, 1 Replacement male orange, 1 Replacement male red	3.8/4.3/5.0	
J2253.0401		Locator® block out spacer	3.3/3.8/4.3/5.0	
J2253.0402		Locator® processing replacement male	3.3/3.8/4.3/5.0	
J2253.1005		Locator® replacement male, clear, STRONG, Div.: 0°–10°		
J2253.1003		Locator® replacement male, pink, MEDIUM, Div.: 0°–10°		
J2253.1002		Locator® replacement male, blue, LIGHT, Div.: 0°–10°		
J2253.2004		Locator® replacement male for extended range, green, STRONG, Div.: 10°–20°		
J2253.2003		Locator® replacement male for extended range, orange, MEDIUM, Div.: 10°–20°		
J2253.2002		Locator® replacement male for extended range, red, LIGHT, Div.: 10°–20°		

LOCATOR® ANCHORING SYSTEM

LOCATOR® INSTRUMENTS

Art. No.		Article
J2253.0004		Locator® parallel post
J2253.0003		Locator® angle measurement guide
J2253.0001		Driver for Locator® abutment, manual/wrench
J2253.0002		Locator® instrument, threepart

LOCATOR® INSTRUMENT

The Locator® instrument consists of three parts screwed together. To remove a processing replacement male or a replacement male, the screw-on tip is loosened three turns counter-clockwise and introduced into the male. When removing, the male is held by the sharp retention edge of the tip. To remove the male from the tip, it is tightened again clockwise on the instrument.

Manufacturer Locator®:
Zest Anchors, Inc.
Escondido, CA 92029, USA

Locator® is a registered trademark
of Zest Anchors, Inc.

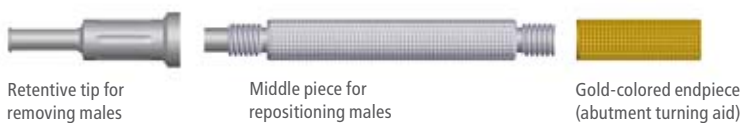

To introduce a processing replacement male or a replacement male into the titanium housing, the middle piece of the Locator® instrument is used. The tip is unscrewed. The required male is positioned on the now visible end and pushed completely into the titanium housing. The gold-colored endpiece can also be unscrewed and can be used as to tighten the CAMLOG® Locator® abutment.

PROCESSING

INSERTION OF THE CAMLOG® LOCATOR® ABUTMENT

To select the suitable CAMLOG® Locator® abutment, the implant diameter and thickness of the gingiva must be known. The thickness of the gingiva determines the required gingival height of the abutment. The exact height of the abutment is selected when the functional region extend out of the surrounding tissue 1.5 mm.

IMPORTANT NOTE

The functional region must be at least 1.5 mm supragingival!



After removing the CAMLOG® healing cap, the inner configuration of the CAMLOG® implant is cleaned. The contact surfaces between implant and abutment must not be covered by bone and tissue. Only then is proper seating of the abutment on the implant ensured.

To insert the CAMLOG® Locator® abutment into the CAMLOG® implant, the gold-colored turning element of the Locator® instrument or the driver for Locator® abutment, manual/wrench, can be used. The driver for Locator® abutment, manual/wrench, is used in conjunction with the torque wrench to tighten the abutment into its final position at the specified torque.

TORQUE FOR CAMLOG® LOCATOR® ABUTMENT

Implant Ø 3.3 mm	20 Ncm
Implant Ø 3.8/4.3/5.0 mm	30 Ncm

Note: CAMLOG® Locator® abutments must be retightened to the same torque after about five minutes.

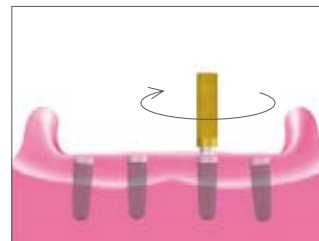

Turning element of the Locator® instrument

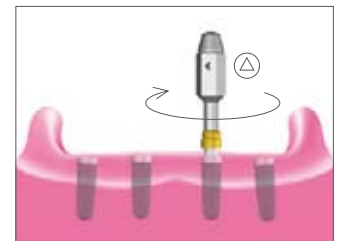

Driver for Locator® abutment, manual/wrench

MEASURING THE IMPLANT AXES

To measure the implant axes, the black parallel posts are positioned on the fixed abutments. The detectable pressure point indicates the exact engagement. The Locator® angle measurement guide can then be used to determine the angle of the individual implant abutments to each other.



Angle measurement guide



Parallel post

LOCATOR® ANCHORING SYSTEM

FABRICATION OF A NEW LOCATOR®-RETAINED FULL DENTURE

IMPRESSION TAKING

The impression is taken over the CAMLOG® Locator® abutments definitely integrated in the CAMLOG® implants using the Locator® impression cap.

An impression cap is positioned on each CAMLOG® Locator® abutment. Pay attention to the proper seating of the impression cap. An impression of the oral situation is then taken using suitable impression materials such as silicone or polyether materials. After the impression material has cured and the tray has been removed, the Locator® impression caps remain in the material.



Locator® impression cap

SELECTING THE REPLACEMENT MALES

The determined values are used to select the suitable Locator® replacement males:

Locator® male processing packages

incl. titanium housing with black processing replacement male, block out spacer white and replacement males (clear, pink, blue)



Locator® male processing packages for extended range

incl. titanium housing with black processing replacement male, block out spacer white and replacement males for extended range (green, orange, red)



REPLACEMENT MALES FOR IMPLANT AXIS DIVERGENCES OF 0°–10° PER IMPLANT

Color: clear

Retention force: STRONG



Color: pink

Retention force: MEDIUM



Color: blue

Retention force: LIGHT



REPLACEMENT MALES FOR IMPLANT AXIS DIVERGENCES OF 10°–20° PER IMPLANT, EXTENDED RANGE (NONLICENSED FOR IMPLANT Ø 3.3 MM)

Color: green

Retention force: STRONG



Color: orange

Retention force: MEDIUM



Color: red

Retention force: LIGHT



The insertion of the Locator® replacement males (are delivered in each male processing package) can be carried out in the dental lab or in the dental practice, according to the chosen integration method.

CAST FABRICATION

After taking the impression, the cast is fabricated using Locator® analogs, which are available in two sizes. The analogs are selected based on the CAMLOG® Locator® abutments used.

NOTE

The CAMLOG® Locator® abutment diameters used are not apparent in the impression and must be communicated to the laboratory to select the Locator® analogs.

SELECTING THE LOCATOR® ANALOG

Locator®
impression cap



Locator® analog	Art. No. J2253.0340	Art. No. J2253.0350
für Locator® abutments	Ø 3.3/3.8/4.3 mm	Ø 5.0 mm

The Locator® analogs designed for the corresponding implant diameters are placed in the Locator® impression caps in the impression. Pay attention to the proper seating of the analogs. The cast is then fabricated with suitable model material.



FABRICATING THE FULL DENTURE

After fabricating the cast, the white block out spacers included in the Locator® male processing packages are pulled over the functional areas of the Locator® analogs to prevent acrylic from getting into the titanium housings.



White block out spacer

The titanium housing with the black processing replacement male is placed on each analog over the previously placed block out spacer until the pressure point is reached.

The titanium housing is attached by the black processing replacement male and the resilience of the denture determined.



Black processing replacement male

CAUTION

Undercuts between the titanium housings and the surrounding tissue not covered by the block out spacers must be blocked out. Acrylic must not get into the titanium housing during fabrication!

The full denture can now be fabricated in the conventional technology.

LOCATOR® ANCHORING SYSTEM

INTEGRATION OF THE COLORED REPLACEMENT MALES

After completing the full denture, the white block out spacers and black processing replacement males are removed from the titanium housings.



The black processing replacement males are removed from the titanium housings using the Locator® instrument. The screw-on tip is turned three rotations counter-clockwise. Then press the retentive tip into the black processing replacement male and remove the male.

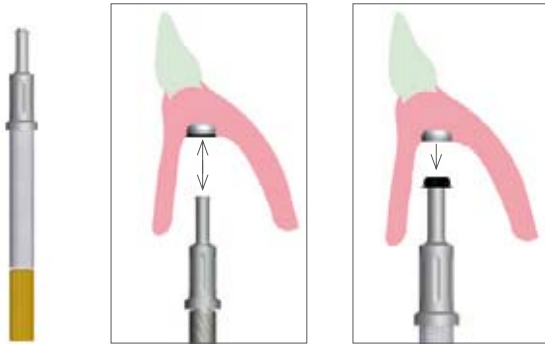

The middle piece of the Locator® instrument is used to integrate the colored replacement male into the empty titanium housing. The tip of the tool is unscrewed, the replacement male positioned and pressed into the titanium housing.

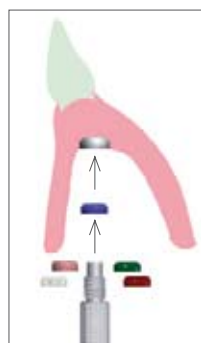

NOTE

The replacement males have no friction on the middle piece. Therefore, keep the middle piece perpendicular and press in the replacement male from the basal view.

CONVERTING AN EXISTING FULL DENTURE INTO A LOCATOR®-RETAINED FULL DENTURE

Locator® components can also be integrated in an existing full denture. After final insertion of the CAMLOG® Locator® abutments in the CAMLOG® implants (see page 55), the Locator® impression caps are positioned on the abutments. Note the proper seating.



The existing prosthesis is then hollow ground in the area of the impression caps.

IMPORTANT NOTE

The impression caps on the CAMLOG® Locator® abutments must not come into contact with the prosthesis when checking the fit in the mouth.

The impression taking in this case is identical to a relining and is taken using the hollow ground prosthesis directly over the impression caps. To ensure that the impression caps remain in the impression, we recommend using suitable impression material such as polyether and silicone compounds.

OPTION: With a small denture base, an impression can also be taken with the titanium housings with black processing replacement males. The reduced retention in the impression must be taken into account.

CAST FABRICATION

The Locator® analogs designed for the corresponding implant diameters are placed in the Locator® impression caps in the impression. Pay attention to the proper seating of the analogs.

NOTE

The CAMLOG® Locator® abutment diameters used are not apparent in the impression and must be communicated to the laboratory to select the Locator® analogs.

The cast is then fabricated with suitable model material.



CONVERTING THE FULL DENTURE

After fabricating the cast, the white block out spacers included in the Locator® male processing packages are pulled over the functional areas of the Locator® analogs to prevent acrylic from getting into the titanium housings.



White block out spacer

The titanium housings with the black processing replacement males are placed on each analog over the previously placed block out spacer until the pressure point is reached.

LOCATOR® ANCHORING SYSTEM



Titanium housing with black processing replacement male

The titanium housing is attached by the black processing replacement male and the resilience of the denture determined.

CAUTION

Undercuts between the titanium housings and the surrounding tissue not covered by the block out spacers must be blocked out. Acrylic must not get into the titanium housings during adaptation!

The titanium housings are then polymerized into the existing full denture and the denture also relined if necessary.

After trimming and polishing the denture, the black processing replacement males are removed and replaced by corresponding replacement male as described in "Integration of the colored replacement males" on page 58.

The finished prosthesis is inserted and the occlusion checked.

CONVERTING AN EXISTING FULL DENTURE INTO A LOCATOR®-RETAINED FULL DENTURE IN THE DENTAL PRACTICE

Locator® components can also be integrated in an existing full denture in the dental practice. After final insertion of the CAMLOG® Locator® abutments in the CAMLOG® implants (see page 55), the white block out spacers included in the Locator® male processing packages are pulled over the functional areas of the CAMLOG® Locator® abutments to prevent acrylic from getting into the titanium housings.

CAUTION

Undercuts between the titanium housings and the surrounding tissue not covered by the block out spacers must be blocked out. Acrylic must not get into the titanium housing during adaptation!

WARNING!

During intraoral use, products must be secured in general against aspiration and swallowing.

The titanium housings with the black processing replacement males are positioned on each CAMLOG® Locator® abutment over the previously placed block out spacers until the pressure point is reached.



The titanium housings are attached by the black processing replacement males and the resilience of the denture determined.

The existing full denture is carefully prepared and perforated in the areas of the titanium housings. The denture must not come into contact during try-in. Contact with the housings can affect the exact positioning of the denture in the mouth. Acrylic can pass through the perforations occlusally.

The titanium housing is polymerized with suitable self-curing polymer in accordance with the manufacturer's instructions. We recommend wetting the titanium housing with acrylic. The denture is then inserted, the exact fit checked and the perforations filled with acrylic. After the acrylic has cured, the denture is removed from the mouth, acrylic overages removed and polished.



The black processing replacement males are then removed and replaced by corresponding replacement males as described in "Integration of the colored replacement males" on page 58. The finished prosthesis is inserted and the occlusion checked.



EXCHANGE OF THE REPLACEMENT MALES IN AN EXISTING FULL DENTURE

The Locator® instrument is used to replace the replacement males if needed. The screw-on tip is turned three rotations counter-clockwise. Press the retentive tip into the replacement male and remove the male.

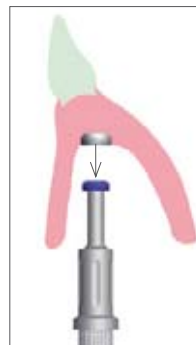

The middle piece of the Locator® instrument is used to integrate the colored replacement males in the empty titanium housing. The tip of the instrument is unscrewed, the replacement males positioned and pressed into the titanium housing.

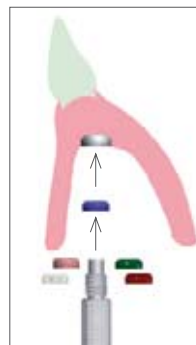

NOTE

The titanium inserts have no friction on the middle piece. Therefore, keep the middle piece perpendicular and press in the replacement males from the basal view.

See also "Integration of the colored replacement males" on page 58.

LOCATOR® ANCHORING SYSTEM

RELINING OF A LOCATOR®-RETAINED FULL DENTURE

The colored replacement males are removed from the titanium housings in the denture and replaced by black processing replacement males using the Locator® instrument. See also "Exchange the replacement males in an existing full denture" on page 61.

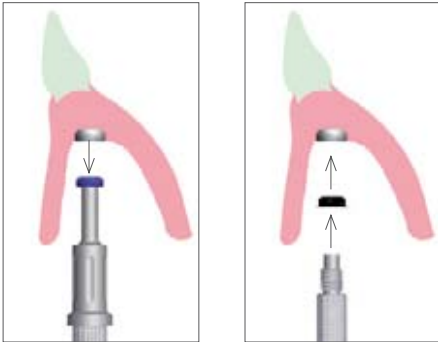

The processing replacement males fix and hold the denture during the relining impression on the CAMLOG® Locator® abutments.

The impression is taken with the denture in the conventional manner. Pay attention to the proper seating of the denture. Impression material must not get into the processing replacement males. After the impression is taken successfully, the black processing replacement males remain in the titanium housings of the denture. The relining impression is handed over to the dental laboratory.

NOTE

To select the matching Locator® analogs for cast fabrication, the dental laboratory must be informed about the diameter of the existing CAMLOG® Locator® abutments.

In the dental laboratory, the respective Locator® analogs are inserted in the black processing replacement males for cast fabrication (see also "Cast fabrication" on page 57).

The cast is then fabricated and the relining impression is secured in the conventional manner.

NOTE

We recommend replacing the existing titanium housings in the denture.

After opening the secured relining impression and removing of the impression from the cast, the black processing replacement males incl. the titanium housings are removed from the denture. The white block out spacers are placed over the functional areas of the Locator® analogs on the cast. This prevents acrylic from getting into the titanium housings.



A titanium housing with the black processing replacement male is placed on each analog over the previously placed block out spacer until the pressure point is reached. The titanium housing is attached by the black processing replacement males and the resilience determined.



Titanium housing with black processing replacement males

NOTE

Undercuts between the titanium housings and the surrounding tissue not covered by the block out spacers must be blocked out. Acrylic must not get into the titanium housings when finishing!

The denture is prepared for the relining and ground out in the area of the Locator® titanium housings. The titanium housings must not come into contact with the prosthesis when assembling the secured impression with the cast. The prosthesis is relined in the conventional manner.

After trimming and polishing, the black processing replacement males are removed and replaced by corresponding colored replacement males as described in "Integration of the colored replacement males" on page 58. The finished prosthesis is inserted and the occlusion checked.

DOUBLE CROWN RESTORATIONS

INTRODUCTION

For removable superstructures, we recommend inserting at least 6 implants in the maxilla and at least 4 implants in the mandible. The prosthesis design should prevent overloads by extensions. The tension-free seat of a secondary (double crown) or primary (bar) splinted structure on implants is called as "passive fit". With double crown constructions, this is obtained through intraoral bonding of the secondary copings (e.g. electroformed copings) to a tertiary framework. The tension-free seat of the superstructure is of paramount importance for the long-term prognosis of a prosthetic restoration. We recommend bonding secondary copings intraorally in the tertiary framework.

PRODUCT DESCRIPTION

The rotational stability of the CAMLOG® Tube-in-Tube™ connection and high precision manufacturing make the CAMLOG® abutments ideally suited for fabrication of double crown restorations. Two different methods are used for fabricating the secondary copings:

- Electroformed secondary copings.
- Cast secondary copings similar to the double crown technique.

IMPRESSION TAKING AND CAST FABRICATION

The impression for double crown restorations with CAMLOG® universal, telescopic and gold-plastic abutments are taken with CAMLOG® impression posts, open or closed tray.

NOTE

For double crown restorations with CAMLOG® universal abutments PS, the impression is taken with CAMLOG® impression posts PS, open or closed tray.

For cast fabrication, CAMLOG® lab analogs are used. For information about "Impression taking directly over the CAMLOG® implant shoulder" and subsequent "Cast fabrication with the CAMLOG® lab analog", see pages 12–15.

CAST FABRICATION FOR MILLING TECHNIQUE

For milling the CAMLOG® abutments, we generally recommend creating a separate milling cast. The milling cast is fabricated by transferring the CAMLOG® lab analog positions from the working cast using CAMLOG® impression posts, which are connected in a transfer construction with suitable acrylic. The construction is connected with acrylic in the retentive area of the impression posts. Acrylic must not get on the fixing screws.

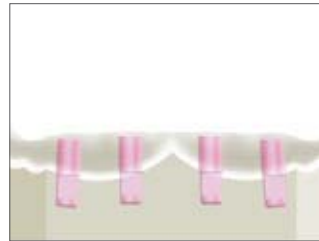

Working cast with CAMLOG® lab analogs



Placing the CAMLOG® impression posts, open tray

DOUBLE CROWN RESTORATIONS



Acrylic connection with transfer construction in the parallelometer

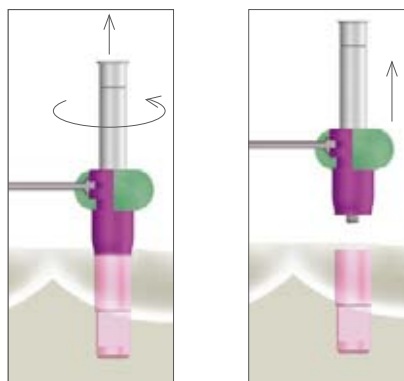

Loosening the CAMLOG® impression posts

After the acrylic cures, the CAMLOG® impression posts are attached to CAMLOG® lab analogs and the milling cast is created in super-hard dental stone. Pay attention to the correct diameter (color-coding).

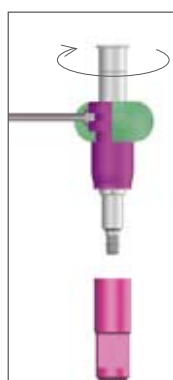

Screwed fixation with CAMLOG® lab analog

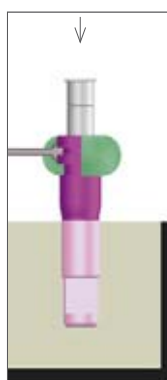

Fabricating the milling cast

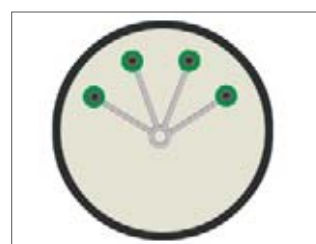

CAMLOG® LAB SCREW (HEX)

To fabricate the prosthetic restoration, we recommend using the CAMLOG® lab screws (hex) exclusively for attaching the CAMLOG® abutments to the casts.

Art. No.	J4006.1601	J4006.2001
CAMLOG® Lab screws, hex		
Thread	M 1.6 for implant Ø 3.8/4.3 mm	M 2.0 for implant Ø 5.0/6.0 mm

The CAMLOG® lab screws are brown anodized and tightened by hand only. New unused CAMLOG® abutment screws (hex) are used for final insertion of the restoration.

CAMLOG® UNIVERSAL ABUTMENT AND CAMLOG® UNIVERSAL ABUTMENT PS FOR PLATFORM SWITCHING

Both CAMLOG® universal abutments can be used for double crown restorations. The CAMLOG® universal abutments are made of titanium alloy and can be custom trimmed. Implant divergences of max. 20° to the implant axis can be compensated for by a suitably adapted forming. The color-coded CAMLOG® universal abutments are available in diameters 3.8/4.3/5.0/6.0 mm incl. CAMLOG® abutment screws.

IMPORTANT NOTES

- All prosthetic components for platform switching have the PS label and K article number (K-Series).
- The platform switching option for double crowns is only possible with the CAMLOG® Universal Abutments PS on CAMLOG® SCREW-LINE implants (K-Series).

CAMLOG® UNIVERSAL ABUTMENT

Art. No.	K2211.3800	K2211.4300	K2211.5000	K2211.6000
				

CAMLOG® UNIVERSAL ABUTMENT PS

Art. No.	K2201.3800	K2201.4300	K2201.5000	K2201.6000
				

NOTE

The CAMLOG® universal abutment with Ø 3.3 mm is not suitable for double crown restorations.

CAMLOG® TELESCOPE ABUTMENT

The design of the CAMLOG® telescope abutment enables the fabrication of double crowns even in heavily unparallel placement of implants. The customizable CAMLOG® abutment has an occlusally widened cone angle of 5°. Implant divergences of max. 20° to the implant axis can be compensated

for by a suitably adapted forming. The color-coded CAMLOG® universal abutment is available in diameters 3.8/4.3/5.0/6.0 mm incl. CAMLOG® abutment screws.

CAMLOG® TELESCOPE ABUTMENT

Art. No.	K2212.3800	K2212.4300	K2212.5000	K2212.6000
				

DOUBLE CROWN RESTORATIONS

PROCESSING THE CAMLOG® ABUTMENTS

EXAMPLE OF THE CAMLOG® UNIVERSAL ABUTMENT

After fabricating the cast, the CAMLOG® universal abutments are inserted into the CAMLOG® lab analogs and fixed with the CAMLOG® lab screw. A previously prepared silicone index is used to mark the height and axis alignments.

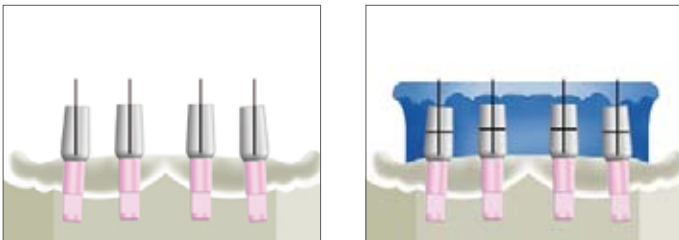

The height of the abutments is first adjusted. The height of the circular functional surface must not fall below 5 mm, otherwise sufficient retention strength of the construction cannot be achieved. The uniform insertion direction is then determined and the abutments are machined with suitable abrasives in the parallelometer. The specified speeds of each abrasive used for titanium machining must be observed.

Overheating the titanium leads to a very hard surface (alpha case layer) and should be avoided.

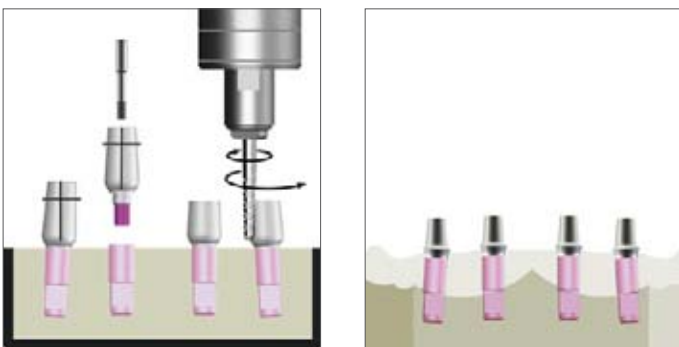

For fabrication of double crowns using the electroplating technique, the manufacturer's specifications must be observed. Cast fabrication of double crowns are prepared similar to the cone telescopic crown technique. To prevent the caps from rotating, the abutments are lightly ground in oval form. The surface must be homogeneous.

The space for the tertiary framework required to receive the secondary crowns can be tested at every phase of preparation with the silicone index with the denture teeth in position.

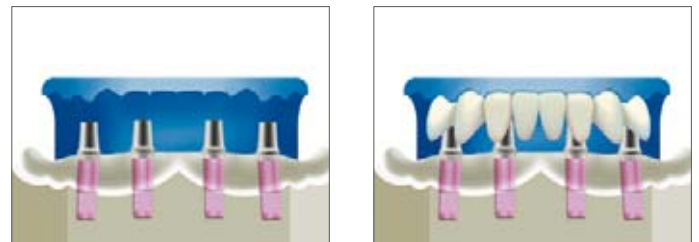

Check of the space conditions with the silicone index on the working cast

FABRICATING THE SECONDARY CROWNS

The secondary crowns or superstructure are then fabricated. The tension-free seat of the superstructure is of paramount importance for the long-term success of an implant-prosthetic restoration. We recommend bonding the secondary copings intraorally in the tertiary framework (passive fit).

NOTES

Electroformed secondary copings

Electroforming is conducted as specified by the manufacturer. The CAMLOG® abutments are inserted into a CAMLOG® lab analog of the appropriate diameter and fixed with a CAMLOG® lab screw. The thickness should be 0.2–0.3 mm. The special feature of the low layer thickness of the electroformed components and the resulting low stability of the secondary coping prevent direct polymerization in the acrylic denture base. For this reason, a tertiary framework must be fabricated over the secondary copings for reinforcement.

Cast secondary copings

The wall thickness of the secondary copings should be approx. 0.5 mm. Fabrication is similar to standard crown and bridge technique.

CAUTION

Do not mix up the CAMLOG® abutments and secondary copings! We recommend a color buccal marker on the abutment, coping and working cast.

FABRICATING A TERTIARY FRAMEWORK FOR DOUBLE CROWN RESTORATIONS

A metal framework is essential for stabilizing the acrylic base and securely retaining the secondary coping. To fabricate the tertiary framework, the working cast is blocked out, the coping is waxed over (0.3 mm for bonding gap) and then duplicated.

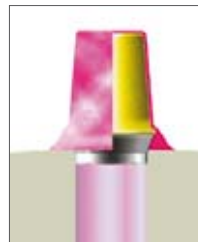

Overwaxing/blocking out the working cast

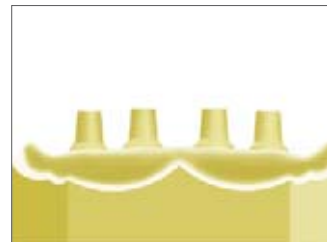

Finished duplicate cast

The tertiary framework is built in wax on the duplicate cast with the silicone index as a control.

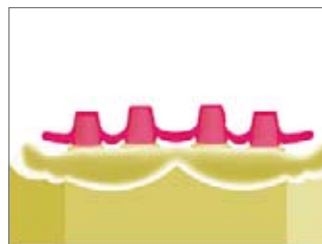

The cervical margin of the secondary coping must be completely reproduced in metal.

The tertiary framework can be fabricated from titanium or non-precious alloy. Then roughen (e.g. sandblasting) the adhesive bonding surfaces of the secondary copings and tertiary framework to improve adhesion. The subsequent steps for complete fixation of the secondary components are done in the patient's mouth.

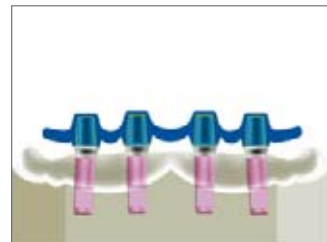
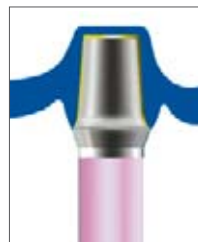

BONDING OF THE SECONDARY COPING INTRAORALLY

We recommend bonding the secondary copings in the tertiary framework intraorally with a suitable metal bonding material. The modified CAMLOG® abutments (primary crowns) are placed in the cleaned CAMLOG® implants and the CAMLOG® abutment screw is hand-tightened. The secondary copings are then placed on the CAMLOG® abutments. Then the tertiary framework is placed and the fit is checked with the secondary coping to ensure that it is seated securely and with an even cement gap.

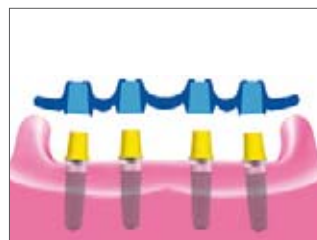

DOUBLE CROWN RESTORATIONS

Follow the manufacturer's instructions for bonding.

After the metal bonding material has set, the framework is removed from the mouth with the secondary coping bonded in without tension. The abutments are removed and sent to the dental laboratory for finishing the secondary coping/CAMLOG® abutment transition. If the bonded tertiary framework cannot be replaced on the master cast without tension, the interfering abutment is removed from the master cast for further procedures.

The bonded points are trimmed (removal of excess material and filling of the gap if too little adhesive was used), the construction is coated with a denture-colored opaque layer to improve the cosmetic appearance (optional) and the denture is finished.

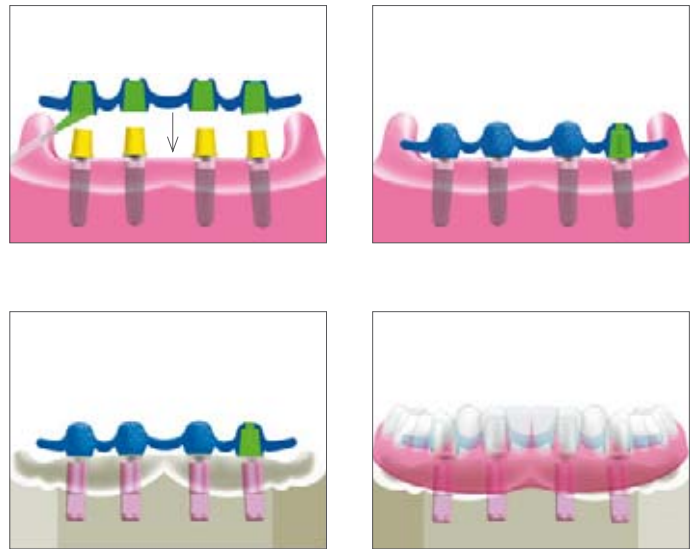

INSERTION OF THE PROSTHETIC RESTORATION

The modified CAMLOG® abutments (primary crowns) are placed in the cleaned CAMLOG® implants and fixed with new unused CAMLOG® abutment screws. The torque wrench and a screwdriver (hex) are used to tighten the screws in the implant to the specified torque of 20 Ncm.

CAMLOG® abutment screws must be retightened to the same torque after about five minutes to reach the maximum screw tension. This prevents screws from loosening.

The screw channels can then be sealed with suitable materials (e.g. composite) for hygiene reasons. The screw inner configurations are first filled with pliable removable material.





TIP: When sealing the screw channel in the abutments (primary components), ensure that the final surface is concave. All acrylic residue must be removed to ensure that the prosthesis is perfectly seated.

CAMLOG® GOLD-PLASTIC ABUTMENT

The CAMLOG® gold-plastic abutment consists of a prefabricated cast-on base part made of a non-oxidizing, high-melting cast-on gold alloy and a screw channel made of burn-out plastic (POM). The screw channel represents a modeling aid and ensure a clean finish of the screw channel. The screw channel is color-coded, firmly connected to the base part and can be individually shortened occlusally.

The CAMLOG® gold-plastic abutment with the cast-on technique can be used to fabricate primary pillars for bridging implant axis divergences in the double crown technique. The color-coded CAMLOG® gold-plastic abutments are available in diameters 3.8/4.3/5.0/6.0 mm incl. CAMLOG® abutment screws.

CAMLOG® GOLD-PLASTIC ABUTMENT

Art. No.	K2246.3800	K2246.4300	K2246.5000	K2246.6000
				
Noble metal weight	approx. 0,46 g	approx. 0,65 g	approx. 0,81 g	approx. 0,89 g

NOTE

The CAMLOG® gold-plastic abutment with Ø 3.3 mm is not suitable for double crown restorations.

The high-melting cast-on gold alloy is only suitable for the cast-on procedure with high-gold alloys.

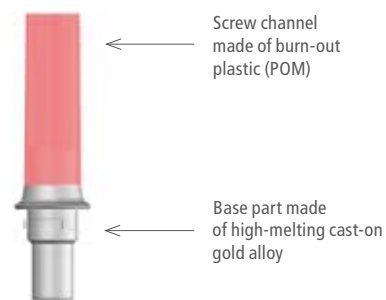

Gold-Plastic Abutment

PROCESSING THE CAMLOG® GOLD-PLASTIC ABUTMENT MODIFICATION OF THE SCREW CHANNEL

After fabricating the cast, the CAMLOG® gold-plastic abutments are inserted into the CAMLOG® lab analogs and fixed with the CAMLOG® lab screw. A previously prepared silicone index is used to mark the required height on the plastic sleeve. The height of the circular functional surface must not fall below 5 mm, otherwise sufficient retention strength of the construction cannot be achieved.

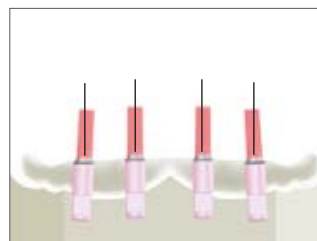

DOUBLE CROWN RESTORATIONS

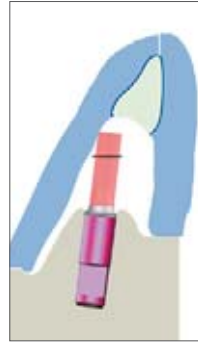
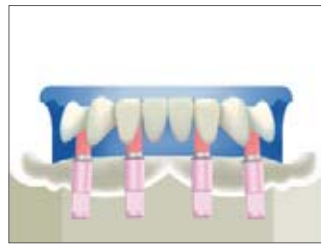
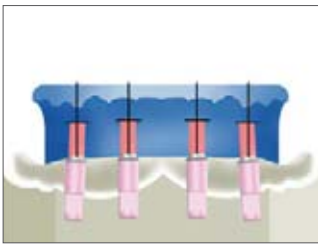

WAX-UP OF THE PRIMARY COMPONENTS

The primary crowns are waxed up with the CAMLOG® gold-plastic abutment similar to the conventional double crown technique. The minimum wax thickness over the base part must be 0.7 mm to achieve an optimal discharge behavior of the cast-on alloy.



CAUTION

Do not cover the fine gold margin (0.3 mm) with wax. This can lead to a surplus of cast-on alloy on the margin or on the implant shoulder support.

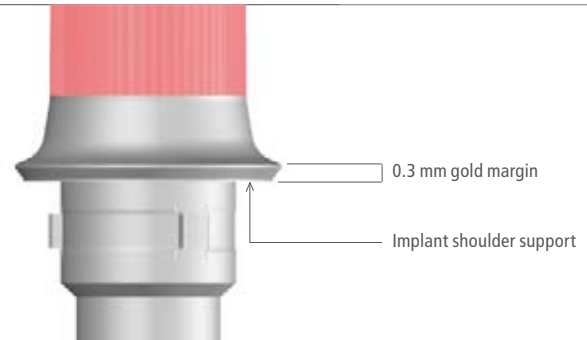

After wax-up, a suitable agent must be used to clean the fine gold margin and the area of the implant shoulder support of separating medium and wax particles (e.g. with a cotton swab soaked in alcohol).

EMBEDDING AND CASTING

The abutment is embedded according to the instruction manual of the muffle system used. We do not recommend the use of a wax wetting agents. The fine film from the agent can lead to a surplus of cast-on alloy on the margin or on the implant shoulder support. When embedding, the correct placement of the wax-up in the casting muffle is of importance. Volume ratios and pin angles must be selected so that the required temperature for formation of a metallic connection is achieved. This is particularly important for voluminous casts.



The investment material must be matched with the cast-on alloy and the casting alloy used. We recommend phosphate bound investment materials. The manufacturer's processing instructions must be observed and the mixing ratios and preheating times accurately observed. We recommend you do not use any quick heating processes (speed investment materials). The cast delay time must be kept as brief as possible.

INSTRUCTIONS FOR THE CAST-ON ALLOYS

The cast-on alloy may not exceed the liquidus temperature of 1350°C (2462°F) in its melting range. The melting range of the high-melting cast-on gold alloy of the abutment lies between 1400°C–1490°C (2552°F–2714°F).

The cast-on alloy must be highly gold-bearing in its components and be compatible with the high-melting cast-on gold alloy. Observe the instructions of the alloy manufacturer.

The use of other cast-on alloys is not recommended because gold alloys with nickel or cobalt components can destroy the base part.

Components of an unsuitable alloy can lead to phases with reduced corrosion resistance, less stability or a low melting range thanks to "diffusion processes" in the border zone "casting alloy/cast-on alloy".

DEVESTMENT

After casting, the cast object must be slowly cooled to room temperature and the object gently devested.

IMPORTANT NOTE

Never use sandblasting to devest the cast; this would destroy the precise fit of the CAMLOG® abutment on the CAMLOG® implant shoulder!

We recommend gentle devestment in an ultrasonic bath with waterjet or stripping.

CASTING QUALITY

If the cast object exhibits casting defects after devestment such as incomplete effluence or casting fins/bubbles over the margin onto the implant shoulder support, the work should be repeated. The precision of the prefabricated base part is severely affected and also the long-term success of the prosthetic restoration.

TRIMMING

After casting, the CAMLOG® gold-plastic abutments can be processed on a previously prepared milling cast with suitable abrasives in the parallelometer.

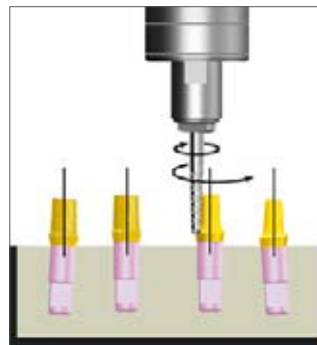

DOUBLE CROWN RESTORATIONS

For fabrication of double crowns using the electroplating technique, the manufacturer's specifications must be observed. The preparation for the cast fabrication of double crowns occurs similar to the cone-telescopic crown technique. To prevent the caps from rotating, the abutments are lightly ground in oval form. The surface must be homogeneous.

The space for the tertiary framework required to receive the secondary crowns can be tested at every phase of preparation with the silicone index with the denture teeth in position.

FABRICATING SECONDARY COPINGS

The secondary crowns or superstructure are then fabricated. The tension-free seat of the superstructure is of paramount importance for the long-term success of an implant-prosthetic restoration. We recommend bonding the secondary copings intraorally into the tertiary framework (passive fit).

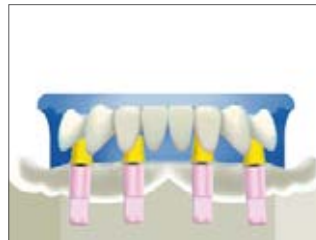

NOTES

Electroformed secondary copings

Electroforming is conducted as specified by the manufacturer. The CAMLOG® abutments are inserted into a CAMLOG® lab analog of the appropriate diameter and fixed with a CAMLOG® lab screw. The thickness should be 0.2–0.3 mm. The special feature of the low layer thickness of the electroformed components and the resulting low stability of the secondary coping prevent direct polymerization in the acrylic denture base. For this reason, a tertiary framework must be fabricated over the secondary copings for reinforcement.

Cast secondary copings

The wall thickness of the secondary copings should be approx. 0.5 mm. Fabrication is similar to standard crown and bridge technique.





CAUTION

Do not mix up the CAMLOG® abutments and secondary copings! We recommend a color buccal marker on the abutment, coping and working cast.



For information about "Fabricating a tertiary framework for double crown restorations", "Bonding of the secondary coping intraorally" and "Insertion of the prosthetic restoration", see pages 67–68.

ACCESSORIES AND PROSTHETIC INSTRUMENTS



CAMLOG® LAB ANALOGS FOR CAST FABRICATION

Art. No.	J3010.3300	J3010.3800	J3010.4300	J3010.5000	J3010.6000
					
Ø mm	3.3	3.8	4.3	5.0	6.0



CAMLOG® LAB SCREWS (HEX) FOR SECURING CAMLOG® ABUTMENTS TO THE CAST

Art. No.	Article
J4006.1601	 CAMLOG® lab screw (hex), brown anodized, Thread M 1.6, for implant diameters 3.3/3.8/4.3 mm
J4006.2001	 CAMLOG® lab screw (hex), brown anodized, Thread M 2.0, for implant diameters 5.0/6.0 mm





SCREWDRIVER, HEX

Art. No.	Article
J5316.0510	 Screwdriver (hex), extra short
J5316.0501	 Screwdriver (hex), short
J5316.0502	 Screwdriver (hex), long





UNIVERSAL HOLDER

Art. No.	Article
J3709.0010	 Universal holder, incl. 2 CAMLOG® lab screws (thread M 1.6 and M 2.0) and each 1 CAMLOG® abutment collect for implant diameters 3.3/3.8/4.3/5.0/6.0 mm
J3709.0015	 Universal holder

REAMER FOR DILATING THE PLASTER MODEL, FOR UNIVERSAL HOLDER, incl. color-coded guide pin

Art.-Nr.	J3706.3300	J3706.3800	J3706.4300	J3706.5000	J3706.6000
					
Ø mm	3.3	3.8	4.3	5.0	6.0

REWORKING REAMER, FOR BASE FOR BAR ABUTMENTS

Art. No.	Article
J3711.0010	 Plane surface/cone seat, burn-out for implant diameters 3.3/3.8/4.3 mm
J3711.0015	 Plane surface/cone seat, burn-out for implant diameters 5.0/6.0 mm
J3711.0020	 Screw seat, burn-out for implant diameters 3.3/3.8/4.3 mm
J3711.0025	 Screw seat, burn-out for implant diameters 5.0/6.0 mm

MATERIALS

TITANIUM GRADE 4

PROPERTIES:

Chemical structure (in %):	O	0.4 max.
	Fe	0.3 max.
	C	0.1 max.
	N	0.05 max.
	H	0.0125 max.
	Ti	> 99.0
	Mechanical properties:	Tensile strength
Elongation		10 %

TITANIUM ALLOY Ti6Al4V ELI

PROPERTIES:

Chemical structure (in %):	Al	5.5–6.75 max.
	V	3.5–4.5 max.
	Fe	0.3 max.
	C	0.08 max.
	N	0.05 max.
	H	0.015 max.
	Ti	~ 90
Mechanical properties:	Tensile strength	860 MPa min.
	Elongation	10 %

CAST-ON GOLD ALLOY

GOLD PLASTIC ABUTMENT

PROPERTIES:

Chemical structure (in %):	Au	60
	Pd	20
	Pt	19
	Ir	1
Physical properties:	Melting range	1400–1490 °C
	Density	17.5 g/cm ³
	E-Modul	136 GPa
	Coefficient of thermal expansion (20–500°C)	11.9 µm/m·°C
	Coefficient of thermal expansion (20–600°C)	12.2 µm/m·°C
	Color	white
	Mechanical properties:	
Hardness HV5		> 215
Tensile strength (Rm)		> 750 MPa
0.2% Elongation limit (Rp 0.2%)		> 650 MPa
Elongation at break		> 2 %

FURTHER DOCUMENTATION

Further information about CAMLOG® products is available in the following documentations:

- CAMLOG product catalog
- CAMLOG working instructions
- Preparation instructions
- CAMLOG instruction manuals (included with CAMLOG® products as package inserts)
- www.camlog.com

TRADEMARKS AND COPYRIGHT

Protected brand names (trademarks) are not specially indicated. The absence of such indication does not mean that it is not a trademarked name. The publication with all its parts is protected by copyright. Any exploitation beyond the narrow limits of the copyright act is not permissible without the approval of CAMLOG Biotechnologies AG and is subject to legal sanctions.



HEADQUARTERS

CAMLOG Biotechnologies AG | Margarethenstrasse 38 | CH-4053 Basel | Switzerland
Tel +41 61 565 41 00 | Fax +41 61 565 41 01 | info@camlog.com | www.camlog.com

Manufacturer of CAMLOG® products: ALTATEC GmbH, Maybachstraße 5, D-71299 Wimsheim, Germany

